

EDC704GEWA



---

**EN** Tumble Dryer  
**CN** 滚筒式干衣机

---

**User Manual**  
**用户手册**

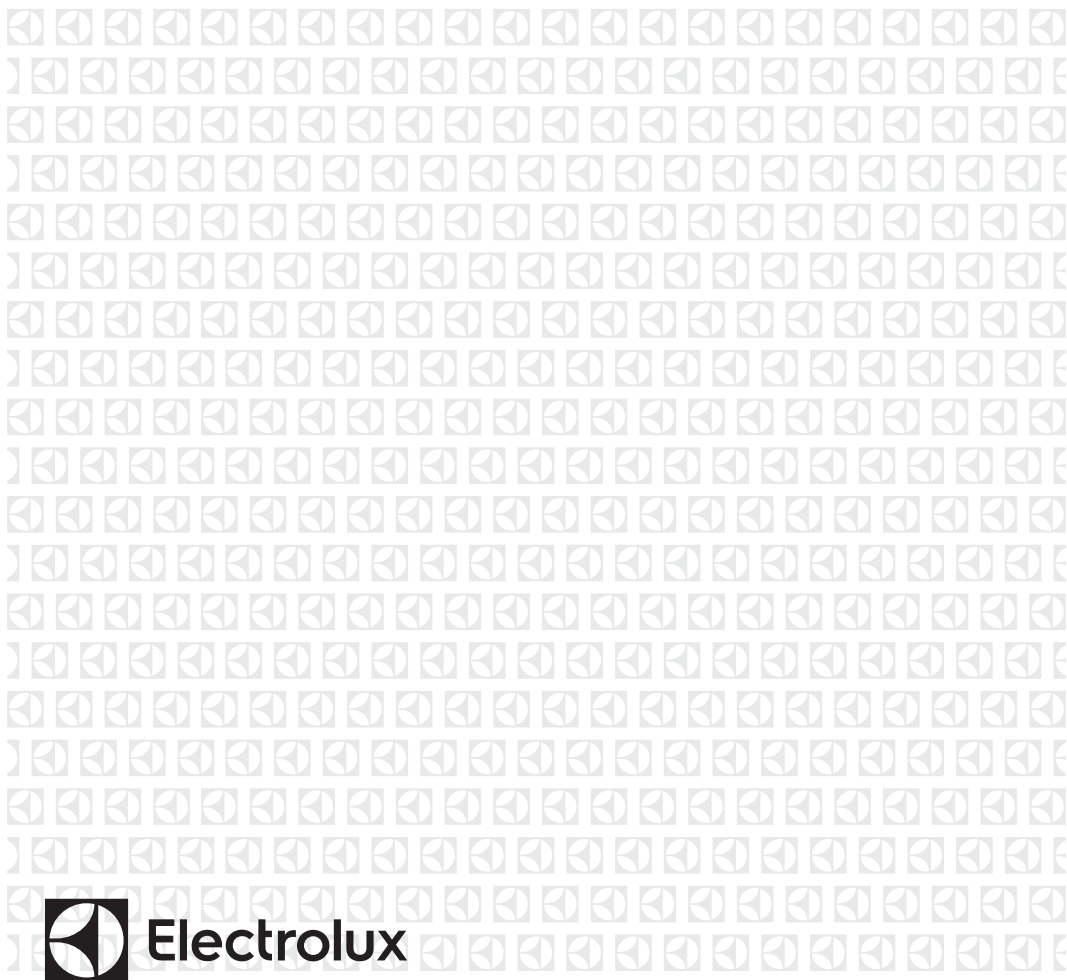

**Electrolux**

## CONTENTS

1. SAFETY INFORMATION.....	2
2. SAFETY INSTRUCTIONS.....	5
3. PRODUCT DESCRIPTION.....	6
4. CONTROL PANEL.....	7
5. PROGRAMME TABLE.....	8
6. OPTIONS.....	9
7. SETTINGS.....	10
8. BEFORE FIRST USE.....	12
9. DAILY USE.....	12
10. HINTS AND TIPS.....	13
11. CARE AND CLEANING.....	14
12. TROUBLESHOOTING.....	17
13. TECHNICAL DATA.....	18
14. QUICK GUIDE.....	19
15. NAME AND CONTENT OF HAZARDOUS SUBSTANCES IN PRODUCTS.....	22

## WE'RE THINKING OF YOU

Thank you for purchasing an Electrolux appliance. You've chosen a product that brings with it decades of professional experience and innovation. Ingenious and stylish, it has been designed with you in mind. So whenever you use it, you can be safe in the knowledge that you'll get great results every time. Welcome to Electrolux.

**Visit our website:**



Get usage advice, brochures, trouble shooter, service information:  
[www.electrolux.com](http://www.electrolux.com)

## CUSTOMER CARE AND SERVICE

Always use original spare parts.

When contacting our Authorised Service Centre, ensure that you have the following data available: Model, PNC, Serial Number.

The information can be found on the rating plate.

 Warning / Caution-Safety information

 General information and tips

 Environmental information

Subject to change without notice.

### 1. SAFETY INFORMATION

Before beginning the installation and use of this appliance, carefully read the supplied instructions. The manufacturer is not responsible for any injuries or damages that are the result of incorrect installation or

usage. Always keep the instructions in a safe and accessible location for future reference.

## 1.1 Children and vulnerable people safety



### **WARNING!**

Risk of suffocation, injury or permanent disability.

- This appliance can be used by children aged from 8 years and above and persons with reduced physical, sensory or mental capabilities or lack of experience and knowledge if they have been given supervision or instruction concerning the use of the appliance in a safe way and understand the hazards involved.
- Children between 3 and 8 years of age and persons with very extensive and complex disabilities shall be kept away from the appliance unless continuously supervised.
- Children of less than 3 years of age should be kept away from the appliance unless continuously supervised.
- Do not let children play with the appliance.
- Keep all packaging away from children and dispose of it appropriately.
- Keep detergents away from children.
- Keep children and pets away from the appliance when the door is open.
- If the appliance has a child safety device, it should be activated.
- Children shall not carry out cleaning and user maintenance of the appliance without supervision.

## 1.2 General Safety

- Do not change the specification of this appliance.
- If the tumble dryer is put on top of a washing machine, use the stacking kit. The stacking kit, available from your authorized vendor, can be used only with the appliance specified in the instructions supplied with

the accessory. Read it carefully before installation (refer to the Installation leaflet).

- The appliance can be installed as freestanding or below a kitchen counter with correct space (refer to the Installation leaflet).
- Do not install the appliance behind a lockable door, a sliding door or a door with a hinge on the opposite side, that would prevent the appliance door from being fully open.
- The ventilation opening in the base must not be covered by a carpet, mat, or any floor covering.
- **WARNING:** The appliance must not be supplied through an external switching device, such as a timer, or connected to a circuit that is regularly switched on and off by a utility.
- Connect the mains plug to the mains socket only at the end of the installation process. Make sure that the mains plug is accessible after installation.
- If the mains power supply cable is damaged, it must be replaced by the manufacturer, its Authorised Service Centre or similarly qualified persons to avoid an electrical hazard.
- Do not exceed the maximum load of 7 kg (refer to the "Programme chart" chapter).
- Do not use the appliance if items have been soiled with industrial chemicals.
- Wipe away lint or packaging debris that has accumulated around the appliance.
- Do not run the appliance without a filter. Clean the lint filter before or after each use.
- Do not dry unwashed items in the tumble dryer.
- Items that have been soiled with substances such as cooking oil, acetone, alcohol, petrol, kerosene, spot removers, turpentine, waxes and wax removers should be washed in hot water with an extra amount of detergent before being dried in the tumble dryer.

- Items such as foam rubber (latex foam), shower caps, waterproof textiles, rubber backed articles and clothes or pillows fitted with foam rubber pads should not be dried in the tumble dryer.
- Fabric softeners, or similar products, should only be used as specified by the product manufacturer's instructions.
- Remove all objects from items that could be a source of fire ignition such as lighters or matches.
- **WARNING:** Never stop a tumble dryer before the end of the drying cycle unless all items are quickly removed and spread out so that the heat is dissipated.
- Before any maintenance operation, deactivate the appliance and disconnect the mains plug from the socket.

## 2. SAFETY INSTRUCTIONS

### 2.1 Installation

- Remove all the packaging.
- Do not install or use a damaged appliance.
- Follow the installation instructions supplied with the appliance.
- Always take care when moving the appliance as it is heavy. Always use safety gloves and enclosed footwear.
- Do not install or use the appliance where the temperature can be lower than 5°C or higher than 35°C.
- The floor area on which the appliance is to be installed must be flat, stable, heat resistant and clean.
- Make sure that there is air circulation between the appliance and the floor.
- Always keep the appliance vertical when it is being moved.
- The rear surface of the appliance must be put against a wall.
- When the appliance is in its permanent position, check if it is levelled correctly with the aid of a spirit level. If it is not, adjust the feet accordingly.

### 2.2 Electrical connection



#### **WARNING!**

Risk of fire and electric shock.

- The appliance must be earthed.
- Make sure that the parameters on the rating plate are compatible with the electrical ratings of the mains power supply.
- Always use a correctly installed shockproof socket.
- Do not use multi-plug adapters and extension cables.
- Do not pull the mains cable to disconnect the appliance. Always pull the mains plug.
- Do not touch the mains cable or the mains plug with wet hands.
- This appliance complies with the E.E.C. Directives.

### 2.3 Use



#### **WARNING!**

Risk of injury, electric shock, fire, burns or damage to the appliance.

- This appliance is for household use only.
- Do not dry damaged (torn, frayed) items that contain padding or fillings.
- Only dry fabrics which are suitable for drying in a tumble dryer. Follow the instructions on the fabric label.
- If you have washed your laundry with a stain remover start an extra rinse cycle before you start the dryer.
- Do not drink or prepare food with the condensed water/distilled water. It can cause health problems to people and pets.
- Do not sit or stand on the open door of the appliance.
- Do not dry dripping wet clothes in a tumble dryer.

### 2.4 Care and cleaning



**WARNING!**

Risk of injury or damage to the appliance.

- Do not use water spray and steam to clean the appliance.
- Clean the appliance with a moist soft cloth. Only use neutral detergents. Do not use any abrasive products, abrasive cleaning pads, solvents or metal objects.

### 2.5 Disposal



**WARNING!**

Risk of injury or suffocation.

- Disconnect the appliance from the mains electrical and water supplies.
- Cut off the mains electrical cable close to the appliance and dispose of it.
- Remove the door catch to prevent children or pets from becoming trapped in the drum.
- Dispose of the appliance in accordance with local requirements for the disposal of Waste Electrical and Electronic Equipment (WEEE).

## 3. PRODUCT DESCRIPTION

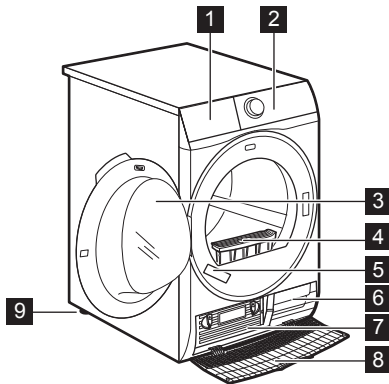

- 1 Water container
- 2 Control panel
- 3 Appliance door
- 4 Filter
- 5 Rating plate
- 6 Airflow slots
- 7 Heat Exchanger lid
- 8 Heat Exchanger cover
- 9 Adjustable feet



For ease of loading laundry or ease of installation the door is reversible. (see separate leaflet).

## 4. CONTROL PANEL

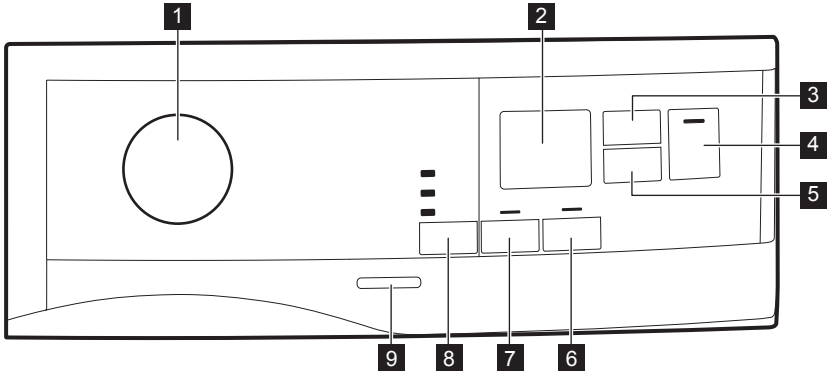

- 1** Programme knob
- 2** Display
- 3** Time Dry touch button
- 4** Start/Pause touch button
- 5** Delay Start touch button
- 6** Extra Anticrease touch button
- 7** Gentle Dry touch button
- 8** Dryness Level touch button
- 9** On/Off button









Press the touch buttons with your finger in the area with the symbol or name of the option. Do not wear gloves when you operate the control panel. Make sure that the control panel is always clean and dry.















### 4.1 Display







Symbol on the display	Symbol description
	time drying option on
	delay start option on
	indicator: <i>check Heat Exchanger</i>

Symbol on the display	Symbol description
	indicator: <i>clean filter</i>
	indicator: <i>drain the water container</i>
	indicator: <i>drying phase</i>
	indicator: <i>cooling phase</i>
	indicator: <i>anti-crease phase</i>
	child lock on
— — —	wrong selection
2 : 0 0	programme duration
: 1 0 - 2 : 0 0	time Drying duration
1 h - 2 0 h	delay start duration

## 5. PROGRAMME TABLE

Programme	Load 1)	Properties / Fabric type <sup>2)</sup>
Favourite ☆	Depends on a memorised programme	You can do your configuration of programme and options and memorise in the appliance memory (See chapter " <i>Settings - Favourite ☆</i> ").
Cottons	<b>7 kg</b>	Cotton fabrics. /  
Mixed	<b>3kg</b>	Cotton and synthetic fabrics. Low temperature programme. Delicate programme with warm air. /   
Bedding	<b>3kg</b>	Bed linen such as single and double sheets, pillowcases, duvet cover. /   
Synthetics	<b>3,5 kg</b>	Synthetic and mixed fabrics. /   
Energy Saver	<b>7 kg</b>	Cycle to be used to dry cotton with "cotton cupboard" dryness level, with maximum energy saving. /   
Refresh	<b>1kg</b>	Refreshing textiles that were in storage.



Programme	Load <sup>1)</sup>	Properties / Fabric type <sup>2)</sup>
Denim	4 kg	Leisure clothing such as jeans, sweat-shirts of different material thicknesses (e.g. at the neck, cuffs and seams). / 
Sports	2 kg	Sportswear, thin and light fabrics, microfiber, polyester. / 
Easy Iron	1 kg (or 5 shirts)	Easy care fabrics for which a minimum of ironing is necessary. The drying results can be different from one type of fabric to another. Shake the items before putting them in the appliance. When the programme has ended, immediately remove the items and put them on a hanger. / 
Shirts	1,5kg (or 7 shirts)/	Easy care fabrics for which a minimum of ironing is necessary. The drying results can be different from one type of fabric to the other. Shake the items before you put them in the appliance. When the programme is completed, Immediately remove the items and put them on a hanger. / 
Wool	1 kg	Woollen fabrics. Gentle drying for hand-washable woollens. Remove items immediately when the programme is completed.
Delicates	4 kg	Delicate fabrics such as viscose, rayon, acrylic, and their blends. / 



<sup>1)</sup> The maximum weight refers to dry items.

<sup>2)</sup> For fabric mark meaning see chapter *HINTS AND TIPS: Preparing the laundry*.

## 6. OPTIONS

### 6.1 Dryness Level

This function helps to increase dryness of the laundry. There are 3 options:

-  Extra Dry
-  Cupboard Dry
-  Iron Dry

### 6.2 Gentle Dry

With this option you can set a delicate drying programme that has a low temperature. Use this option with a

fabrics that have the symbol  on the fabric label (e.g. acrylic, viscose).

### 6.3 Extra Anticrease

Extends the anti-crease phase by 60 minutes at the end of the drying cycle. This function reduces creases. The laundry can be removed during the anti-crease phase.

### 6.4 Time Dry

You can set the programme duration, from a minimum of 10 minutes to a maximum of 2 hours. The required duration is related to the quantity of laundry in the appliance.

**i** We recommend that you set a short duration for small quantities of laundry or for only one item.

### 6.5 Options table

Programmes <sup>1)</sup>	Dryness Level			Gentle Dry	Extra Anti-crease	Time Dry
Favourite ☆	Depends on a memorised programme					
Cottons	■	■	■	■	■	■
Mixed	■	■			■	■
Bedding	■	■	■		■	
Synthetics	■	■	■	■	■	■
Energy Saver		■			■	
Refresh					■	
Denim	■	■		■	■	
Sports		■			■	
Easy Iron				■	■	■
Shirts			■		■	
Wool		■				
Delicates		■		■	■	

<sup>1)</sup> Together with the programme you can set 1 or more options. To activate or deactivate them, press the related touch button.

## 7. SETTINGS

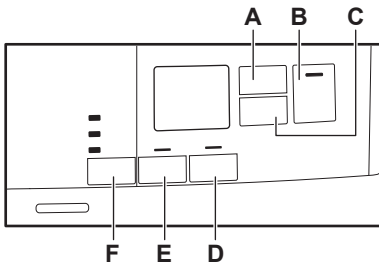

- A. Time Dry touch button
- B. Start/Pause touch button

- C. Delay Start touch button
- D. Extra Anticrease touch button
- E. Gentle Dry touch button
- F. Dryness Level touch button

### 7.1 Child lock function

This option prevents children playing with the appliance while a programme is operating. The touch buttons are locked.

Only the on/off button is unlocked.

## Activating the child lock option:

1. Press the on/off button to activate the appliance.
2. Press and hold touch button (D) for a few seconds.

The child lock indicator comes on.

-  It is possible to deactivate the child lock option while a programme operates. Press and hold the same touch buttons until the child lock indicator goes off. The Child Lock function isn't available for 8 s after switching on the appliance.

## 7.2 Favourite ☆

You can do your configuration of programme and options and memorise in the appliance memory.

### To memorise your configuration:

1. Press the on/off button to activate the appliance
2. Set the programme and available options.
3. Press the (E) button for some seconds.

The sound and the message on the display confirm that the configuration is memorised.

### To activate your memorised configuration:

1. Press the on/off button to activate the appliance.
2. Use the programme knob to set Favourite ☆ position.

Previously memorised configuration of programme and options will be restore.

## 7.3 Adjustment of remaining laundry moisture

-  Every time you enter in the "Adjustment of remaining laundry moisture" mode, previously set degree of remaining moisture will change into next value ( e.g previously set - 2 - will change into - 1 - ).

To change the default degree of remaining moisture:

1. Press the on/off button to activate the appliance.
2. Use the programme knob to set any programme.
3. Wait approximately 8 seconds.
4. Press and hold buttons (E) and (D) at the same time.

One of these indicators comes on:

- - 0 - the maximum dryness
  - - 1 - the more dry laundry
  - - 2 - the standard dry laundry
5. Press and hold buttons (E) and (D) again until the indicator of the correct level comes on.

-  If the display returns to the normal mode (the time of the selected programme from step 2. will be displayed), while setting the degree of remaining moisture, press and hold buttons (E) and (D) once again to enter to the "Adjustment of remaining laundry moisture" mode (previously set degree of remaining moisture will change into next value).

6. After 5 s the display returns to normal mode.

## 7.4 Water container indicator

By default, the water container indicator is on. It comes on when the programme is completed or when it is necessary to empty the water container.



If a draining kit is installed (additional accessory), the appliance automatically drains the water from the water container. In this case we recommend that you deactivate the indicator of the water container.

### Deactivating the water container indicator:

1. Press the on/off button to activate the appliance.
2. Wait approximately 8 seconds.

## 8. BEFORE FIRST USE

Before you use the appliance for the first time:

- Clean the tumble dryer drum with a moist cloth.

## 9. DAILY USE

### 9.1 Start a programme without delay start

1. Prepare the laundry and load the appliance.



#### CAUTION!

Make sure that when you close the door, the laundry does not get caught between the appliance door and the rubber seal.

2. Press the on/off button to activate the appliance.
3. Set the correct programme and options for the type of load.

The display shows the programme duration.

3. Press and hold touch buttons (A) and (C) at the same time.

The display shows one of these 2 configurations:

- The display shows "Off". After 5 s the display returns to normal mode.
- The display shows "On". After 5 s the display returns to normal mode.

### 7.5 Buzzer on/off

To deactivate or activate the acoustic signals, press and hold for approximately 2 seconds touch buttons (E) and (F) at the same time.

- Start a 1 hour programme with moist laundry.



The drying time you see on the display, when the cotton programme is selected, is related to the load of 5 kg and standard conditions . Real drying time will depend on type of the load (quantity and composition), the room temperature and the humidity of your laundry after spin drying phase.

4. Press the Start/Pause touch button. The programme starts.

### 9.2 Starting the programme with delay start

1. Set the correct programme and options for the type of load.
2. Press the delay start button again and again until the display shows the delay time you want to set.

 You can delay the start of a programme from a minimum of 30 minutes to a maximum of 20 hours.





3. Press the Start/Pause touch button. The display shows the countdown of the delay start. When the countdown is completed, the programme starts.

### 9.3 Change a programme

1. Press the on/off button to deactivate appliance
2. Press the on/off button to activate the appliance.
3. Set the programme.

### 9.4 At the end of the programme

When the programme is completed:





- An intermittent acoustic signal operates.
- The display shows 
- The indicator  is on.
- The indicators  Filter and  Tank may come on.
- The Start/Pause indicator is on.

The appliance continues to operate with the anti-crease phase for approximately 30 minutes or more if Extra Antcrease option was set (see chapter *Option - Extra Antcrease*).

The anti-crease phase reduces creasing.

You can remove the laundry before the anti-crease phase is completed. We recommend, for better results, that you remove the laundry when the phase is almost completed.

When the anti-crease phase is completed:

- The display still shows 
- The indicator  is off.
- The indicators  Filter and  Tank remain on.
- Start/Pause indicator goes off.

1. Press the on/off button to deactivate the appliance.
2. Open the appliance door.
3. Remove the laundry.
4. Close the appliance door.

 **Always clean the filter and empty the water container when a programme is completed.**

### 9.5 Stand-by function

To reduce energy consumption, this function automatically deactivates the appliance:





- After 5 minutes if you do not start the programme.
- After 5 minutes from the end of the programme.

## 10. HINTS AND TIPS

### 10.1 Preparing the laundry

- Close the zips.
- Close the fasteners of duvet covers.
- Do not dry ties or ribbons loose (e.g. apron ribbons). Tie them before you start a programme.
- Remove all items from pockets.
- Turn items with the internal layer made of cotton inside out. Cotton layer must be faced outwards.
- Always set the programme suitable for the type of laundry.
- Do not put light and dark colours together.

- Use suitable programme for cottons, jersey and knitwear to reduce shrinkage.
- Do not exceed the maximum load stated in the programmes chapter or shown on the display.
- Dry only the laundry that is suitable for tumble drying. Refer to the fabric label on the items.
- Do not dry large and small items together. Small items can be trapped inside the large items and remain wet.

Fabric label	Description
	Laundry is suitable for tumble drying.
	Laundry is suitable for tumble drying at higher temperatures.
	Laundry is suitable for tumble drying at low temperatures only.
	Laundry is not suitable for tumble drying.

## 11. CARE AND CLEANING

### 11.1 Cleaning the filter

1.

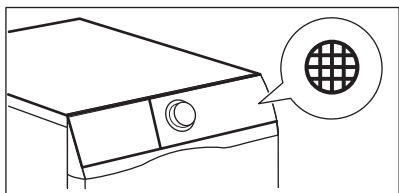

2.

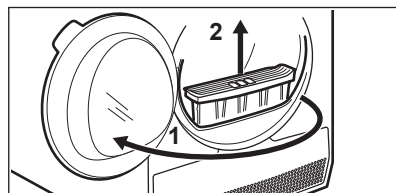

3.

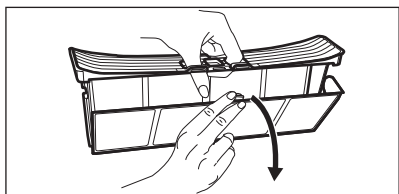

4.

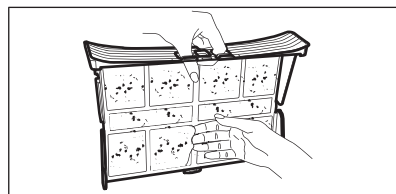

5. 1)

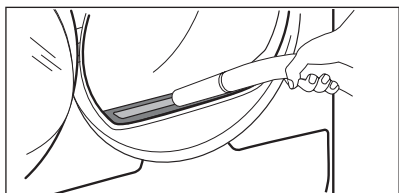

6.

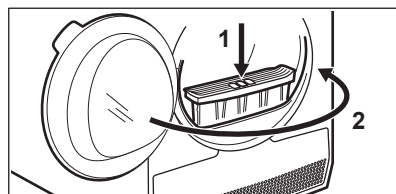

1) If necessary remove fluff from the filter socket and gasket. You can use a vacuum cleaner.

## 11.2 Emptying the water container

1.

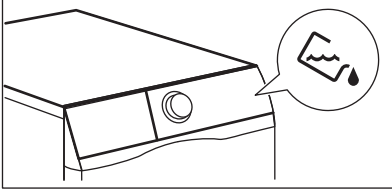

2.

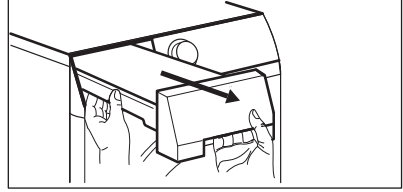

3.

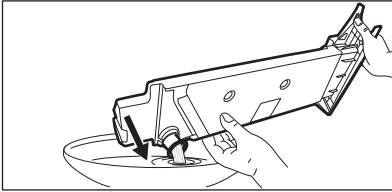

4.

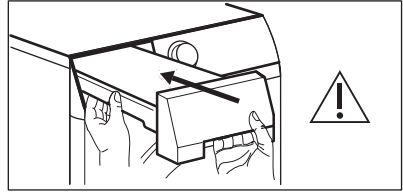

You can use the water from the water container as an alternative to distilled water (e.g. for steam ironing). Before you use the water, remove dirt residues with a filter.

## 11.3 Cleaning the Heat Exchanger

1.

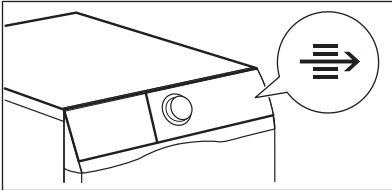

2.

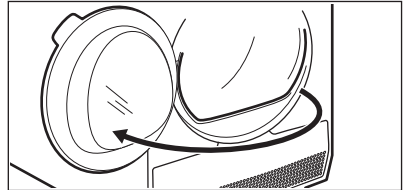

3.

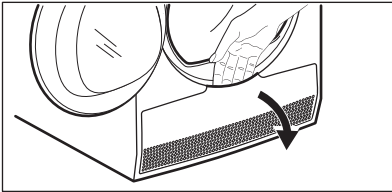

4.

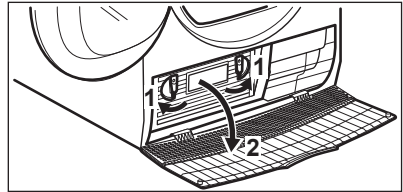

5.

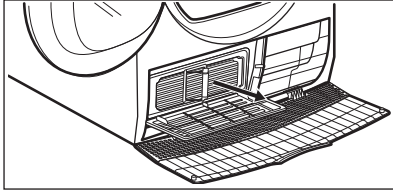

6.

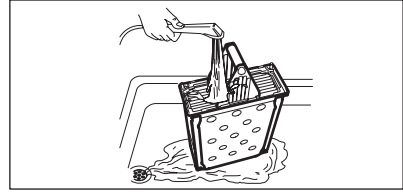

7.

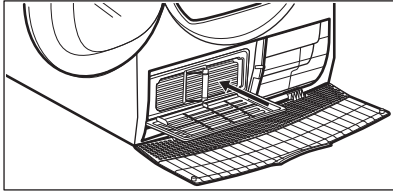

8.

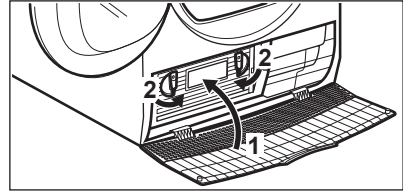

9.

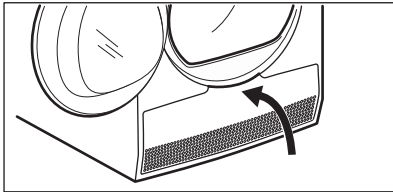

10.

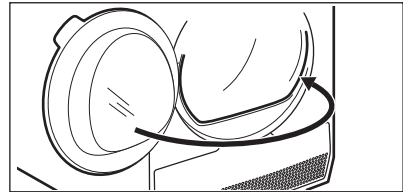

## 11.4 Cleaning the drum



### **WARNING!**

Disconnect the appliance before you clean it.

Use a standard neutral soap detergent to clean the inner surface of the drum and drum lifters. Dry the cleaned surfaces with a soft cloth.



### **CAUTION!**

Do not use abrasive materials or steel wool to clean the drum.

## 11.5 Cleaning the control panel and housing

Use a standard neutral soap detergent to clean the control panel and housing.

Use a moist cloth to clean. Dry the cleaned surfaces with a soft cloth.



### **CAUTION!**

Do not use furniture cleaning agents or cleaning agents which can cause corrosion.

## 11.6 Cleaning the airflow slots

Use a vacuum cleaner to remove fluff from the airflow slots.



## 12. TROUBLESHOOTING

Problem	Possible solution
You cannot activate the appliance.	Make sure that the mains plug is connected to the mains socket.
	Check fuse in fuse box (domestic installation).
The programme does not start.	Press Start/Pause.
	Make sure that the appliance door is closed.
The appliance door does not close.	Make sure that the installation of the filter is correct.
	Make sure that the laundry is not caught between the appliance door and the rubber seal.
The appliance stops during operation.	Make sure that the water container is empty. Press Start/Pause to start the programme again.
	Load is too small, increase the load or use the Time Drying programme.
The cycle time is too long or unsatisfactory drying result. <sup>1)</sup>	Make sure that the weight of the laundry is suitable for the duration of the programme.
	Make sure that the filter is clean.
	The laundry is too wet. Spin the laundry in the washing machine again.
	Ensure that the room temperature is higher than +5°C and lower than +35°C. Optimal room temperature is 19°C to 24°C.
	Set the Time Drying or the Extra Dry programme. <sup>2)</sup>
The display shows — — —.	If you want to set a new programme, deactivate and activate the appliance.
	Make sure that the options are suitable for the programme.
The display shows Error code (e.g. <b>E51</b> ).	Deactivate and activate the appliance. Start a new programme. If the problem occurs again, contact the Service centre.

<sup>1)</sup> After maximum 5 hours, the programme ends automatically.

<sup>2)</sup> It can happen that some area remains humid when drying big items (e.g. bed sheets).

### 12.1 If the drying results are not satisfactory

- The set programme was incorrect.
- The filter is clogged.
- The Heat Exchanger is clogged.
- There was too much laundry in the appliance.
- The drum is dirty.
- Incorrect setting of the conductivity sensor ( See chapter "*Settings - Adjustment of the remaining laundry moisture degree*" for better setting).
- The airflow slots are clogged.
- Room temperature is too low or too high ( optimal room temperature 19°C to 24°C )

## 13. TECHNICAL DATA

Height x Width x Depth	850 x 596 x 570 mm (maximum 594 mm)
Max. depth with the appliance door open	1030 mm
Max. width with the appliance door open	950 mm
Adjustable height	850 mm (+ 15 mm - feet regulation)
Drum volume	104 l
Maximum load volume	7 kg
Voltage	220-230 V
Frequency	50 Hz
Total power	2250 W
Type of use	Household
Permitted ambient temperature	+ 5°C to + 35°C
Level of protection against ingress of solid particles and moisture ensured by the protective cover, except where the low voltage equipment has no protection against moisture	<b>IPX4</b>

## 14. QUICK GUIDE

### 14.1 Daily use

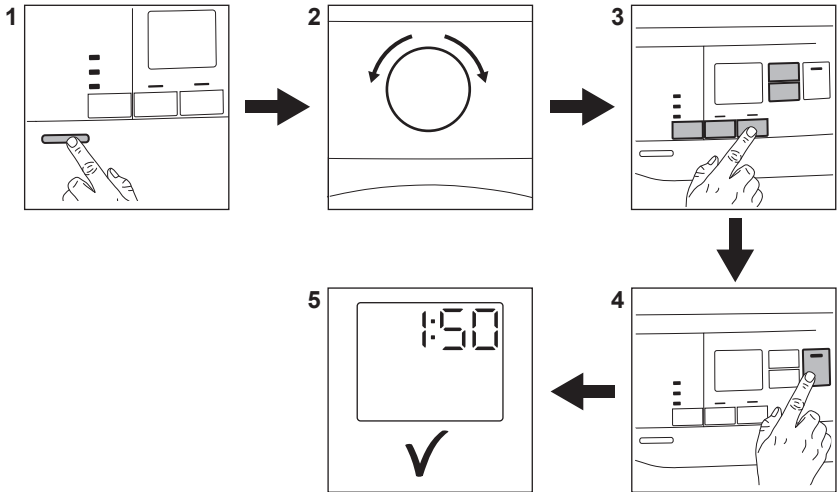

1. Push the On/Off button to turn on the appliance.
2. Use the programme dial to set the programme.
3. Together with the programme you can set 1 or more special options. To activate or deactivate an option touch the relevant button.
4. To start the programme, Touch the **Start/Pause** button.
5. The appliance starts.

### 14.2 Cleaning the filter

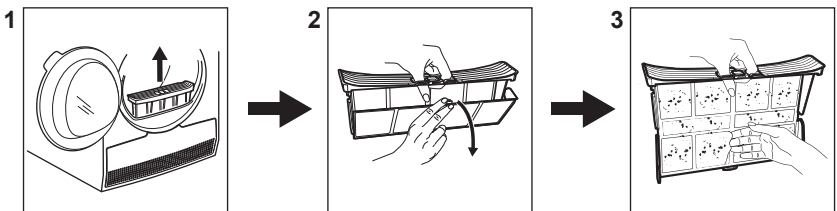

At the end of each cycle the filter symbol  appears on the display and you must clean the filter.

### 14.3 Programme table



Programme	Load 1)	Properties / Fabric type <sup>2)</sup>	
Favourite ☆	Depends on a memorised programme	You can do your configuration of programme and options and memorise in the appliance memory (See chapter " <i>Settings - Favourite</i> ☆").	
Cottons	<b>7 kg</b>	Cotton fabrics.	/ ☺ ☺
Mixed	<b>3kg</b>	Cotton and synthetic fabrics. Low temperature programme. Delicate programme with warm air.	/ ☺ ☺ ☺
Bedding	<b>3kg</b>	Bed linen such as single and double sheets, pillowcases, duvet cover.	/ ☺ ☺ ☺
Synthetics	<b>3,5 kg</b>	Synthetic and mixed fabrics.	/ ☺ ☺ ☺
Energy Saver	<b>7 kg</b>	Cycle to be used to dry cotton with "cotton cupboard" dryness level, with maximum energy saving.	/ ☺ ☺ ☺
Refresh	<b>1kg</b>	Refreshing textiles that were in storage.	
Denim	<b>4 kg</b>	Leisure clothing such as jeans, sweat-shirts of different material thicknesses (e.g. at the neck, cuffs and seams).	/ ☺ ☺ ☺
Sports	<b>2 kg</b>	Sportswear, thin and light fabrics, microfiber, polyester.	/ ☺ ☺ ☺
Easy Iron	<b>1 kg (or 5 shirts)</b>	Easy care fabrics for which a minimum of ironing is necessary. The drying results can be different from one type of fabric to another. Shake the items before putting them in the appliance. When the programme has ended, immediately remove the items and put them on a hanger.	/ ☺ ☺ ☺
Shirts	<b>1,5kg (or 7 shirts)/</b>	Easy care fabrics for which a minimum of ironing is necessary. The drying results can be different from one type of fabric to the other. Shake the items before you put them in the appliance. When the programme is completed, Immediately remove the items and put them on a hanger.	/ ☺ ☺ ☺

Programme	Load <sup>1)</sup>	Properties / Fabric type <sup>2)</sup>
Wool	1 kg	Woollen fabrics. Gentle drying for hand-washable woollens. Remove items immediately when the programme is completed.
Delicates	4 kg	Delicate fabrics such as viscose, rayon, acrylic, and their blends. / 

1) The maximum weight refers to dry items.

2) For fabric mark meaning see chapter *HINTS AND TIPS: Preparing the laundry*.

## 15. ENVIRONMENTAL CONCERNS

Recycle materials with the symbol . Put the packaging in relevant containers to recycle it. Help protect the environment and human health by recycling waste of electrical and electronic appliances. Do not dispose of appliances marked with the symbol  with the household waste. Return the

product to your local recycling facility or contact your municipal office.

Being ensured permissible content limitation of some toxic chemicals (RoHS compliant).

**RoHS**  
Compliant

## Name and content of hazardous substances in products

Part Name	Hazardous Substances					
	Pb	Hg	Cd	Cr6+	PBBs	PBDEs
Cabinet (including hinges)	X	O	O	O	O	O
Drum	O	O	O	O	O	O
Pump, fan & motor	X	O	O	O	O	O
Heat Pump system*	X	O	O	O	O	O
Air duct (including filter)	X	O	O	O	O	O
Control Panel	X	O	O	O	O	O
Door (including door lock)	X	O	O	O	O	O
Condenser & water tank	O	O	O	O	O	O
Worktop	O	O	O	O	O	O
Wirings (including power cord)	X	O	O	O	O	O

**Notes:**

1. This table is compiled according to SJ/T11364-2014.
2. “O” means this kind of hazard substance content in all the homogenous material of this part is under the limitation regulated in GB/T26572-2011.
3. “X” means this kind of hazard substance content in at least in one homogenous material of this part is above the limitation regulated in GB/T26572-2011.
4. For these parts with “X” in the above table, there is no replacement solution due to technique limitation in the industry; however, this may change with the technique improvement.
5. The parts marked with \* means that not applies to all models, the parts actuals depend on specific models.
6. Under normal usage condition, the environment friendly usage period is 15 year.

# 目录

1. 安全信息.....	23
2. 安全说明.....	26
3. 产品描述.....	27
4. 控制面板.....	28
5. 程序表.....	29
6. 选项.....	30
7. 设置.....	31
8. 首次使用前准备.....	33
9. 日常使用.....	33
10. 提示与技巧.....	34
11. 保养与清洁.....	35
12. 故障检修.....	38
13. 技术参数.....	39
14. 快速指南.....	40
15. 环保信息.....	42
16. 维修服务指南.....	43
17. 产品中有害物质名称和含量.....	45

## 想您所想

感谢您选购伊莱克斯电器。您选择的产品蕴含着我们数十年的专业经验和创新。该产品集独创性和时尚性于一身，在设计过程中想您所想，是您的不二之选。每次使用时，都可安心畅享其超凡效果。欢迎来到伊莱克斯的世界。

**请访问我们的网站：**



获取使用建议、手册、故障排除和维修服务信息：

[www.electrolux.com.cn](http://www.electrolux.com.cn)

## 客户关怀与服务

请始终使用原厂备件。

在联系我们的授权服务中心时，请确保提供下列信息：型号、PNC 和序列号。

您可在铭牌上找到这些信息。

 警告/安全警示信息

 一般信息和温馨提示

 环保信息

在中国大陆销售的机器，以中文版说明书为准。

### 1. 安全信息

在开始安装和使用本电器前，请仔细阅读随附的说明书。

对于因安装或使用不当造成的任何伤害或损坏，制造商概不承担任何责任。应始终将说明书放置在安全且触手可及的位置，以便日后查阅。

## 1.1 儿童和弱势群体安全注意事项



警告!

存在令人窒息、受伤及永久残疾的危险。

- 对于 8 岁及以上的儿童，存在身体缺陷、感官或精神障碍、缺乏相关经验及知识的人员，仅应在得到安全使用本机的指导和监督并了解所涉及危害的情况下进行使用。
- 对于 3 到 8 岁的儿童，以及存在极为严重复杂残疾的人员，应让其远离本机，除非一直有人看管。
- 不得让 3 岁以下儿童靠近，除非一直有人看管。
- 请勿让儿童玩弄本机。
- 请确保所有包装材料均远离儿童并对其进行适当处理。
- 请确保洗涤剂远离儿童。
- 请确保在机门打开时儿童和宠物远离本机。
- 如果本机具有儿童安全装置，应将其启用。
- 儿童在无人监督的情况下不得对本机进行清洁和用户维护操作。

## 1.2 一般安全要求

- 请勿更改本机的规格。
- 如果需要将滚筒干衣机放置在滚筒洗衣机上部，则应使用堆叠组件。由您的授权供应商提供的堆叠组件只能用于配件随附说明书中指定的电器。请在安装前仔细阅读（请参阅安装手册）。
- 本机可以独立安装，也可在空间合适的情况下安装在厨房台面下方（请参阅安装手册）。



- 请勿将本机安装于带锁门、推拉门或对面带有铰链的门后面，否则机门可能无法完全打开。
- 底座处的通风口不得被地毯、垫子或任何其他铺地织物所覆盖。
- 警告：本机不得通过外部开关装置（例如定时器）供电，或连接到通过公共设备定时开关的电路上。
- 只有整个安装过程结束后才能将电源插头与电源插座相连接。应确保电源插头在安装完成后易于使用。
- 如果电源线损坏，则必须由制造商、其授权服务中心或具有类似资质的人员进行更换，以免发生电气危险。
- 请勿超出最大装载量 **7 kg**（请参阅“程序图”一章）。
- 请勿使用本机烘干被工业化学品污染的衣物。
- 擦去聚积在本机周围的绒毛线头或包装碎片。
- 请勿在未安装过滤器的情况下使用本机。每次使用前需对绒毛线头过滤器进行清洁。
- 请勿使用干衣机烘干未经洗涤的衣物。
- 被食用油、丙酮、酒精、汽油、煤油、除斑剂、松节油、蜡和除蜡剂等物质污染的衣物应多加一些洗涤剂并使用热水清洗，然后再放入滚筒式干衣机中进行烘干。
- 海绵橡胶（乳胶海绵）、浴帽、防水织物、带有橡胶衬里的衣物，或装有海绵橡胶垫的枕头等物品不应使用本滚筒式干衣机进行烘干。
- 织物柔顺剂或类似产品只能按产品制造商提供的说明书使用。

- 请确保所有物体远离打火机或火柴等可能引起失火的物品。
- 警告：切勿在烘干循环结束前停止滚筒式干衣机，除非快速取出烘干的衣物并分散散热，否则有可能使衣物变形。
- 在进行任何维护操作之前，请停用本机并断开电源插头与插座的连接。

## 2. 安全说明

### 2.1 安装

- 去除所有包装物。
- 请勿安装和使用已损坏的电器。
- 请遵循本机随附的安装说明书。
- 由于本机很重，因此在移动时应始终小心谨慎。始终穿戴安全手套和完全包裹脚掌的鞋子。
- 请勿在温度低于 5°C 或高于 35°C 的环境下安装或使用本机。
- 本机的安装地板必须平坦、稳固、耐热且洁净。
- 请确保本机和地板之间空气可自由循环。
- 移动本机时应始终保持其为直立状态。
- 本机的背面必须靠在墙上。
- 本机位置固定后，借助水平仪检查其是否完全水平。如果不是，请相应地调整底脚。

### 2.2 电气连接



#### 警告！

存在起火和电击的风险。

- 本电器必须接地。
- 确保铭牌上的参数与电源的电气规格一致。
- 务必使用安装正确的防电击插座。
- 请勿使用多插头适配器和延长电源线。
- 请勿通过拉扯电源线来断开本机电源。而是始终拔下电源插头。
- 请勿用湿手触摸电源线或电源插头。

### 2.3 使用



#### 警告！

存在受伤、电击、起火、烧伤或电器损坏的风险。

- 本机仅供家用。
- 请勿使用本机烘干内含填充物或填充物已损坏（撕裂、磨损）的衣物。
- 请仅烘干适合使用滚筒式干衣机烘干的织物。遵循织物标签上的说明。

- 如果使用去污剂对衣物进行了洗涤，请在启动干衣机之前再进行一次漂洗程序。
- 请勿饮用此冷凝水/蒸馏水或用于准备食物。这可能会危害人或宠物的健康。
- 请勿坐在或站在打开的机门上。
- 请勿使用本滚筒式干衣机烘干湿透的衣物。

## 2.4 保养与清洁



### 警告!

存在受伤或电器损坏的风险。

- 请勿使用喷水和蒸汽清洁本机。

- 可使用柔软的湿布清洁本机。只能使用中性洗涤剂。请勿使用任何磨料制品、磨洗垫、溶剂或金属物体进行清洁。

## 2.5 废弃处置



### 警告!

受伤或窒息的危险。

- 断开本机与电源和供水系统的连接。
- 将本机电源线在贴近机身的位置处切断，并妥善处理。
- 拆下门扣以防止儿童或宠物困于滚筒之中。
- 根据当地废弃电子电气设备指令的要求对本机进行废弃处置。

## 3. 产品描述

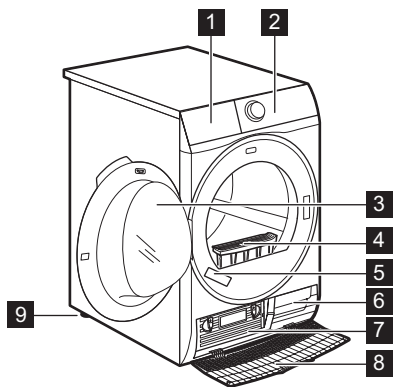

- 1 冷凝水箱
- 2 控制面板
- 3 机门
- 4 绒毛线头过滤器
- 5 铭牌
- 6 气流槽
- 7 换热器盖
- 8 换热器罩
- 9 可调底脚



为了便于装入衣物或便于安装，开门方向可互换。（请参阅单独手册）。

## 4. 控制面板

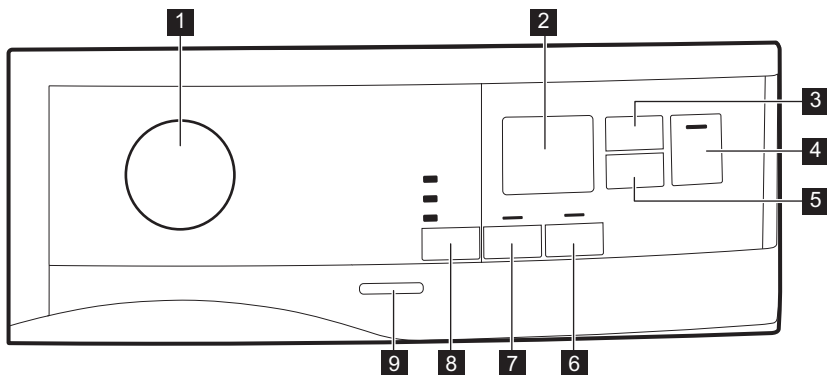

- 1** 程序旋钮
- 2** 显示屏
- 3** 定时烘干触摸键
- 4** 启动/暂停触摸键
- 5** 预约触摸键
- 6** 除皱触摸键
- 7** 轻柔烘干触摸键
- 8** 烘干程度触摸键
- 9** 电源开/关按钮







在有选项符号或名称的区域按下触摸按键。操作控制面板时请勿戴手套。请确保控制面板始终清洁干燥。











### 4.1 显示屏



显示屏上的符号	符号描述
	定时烘干选项打开
	预约选项打开
	指示灯: 检查换热器

显示屏上的符号	符号描述
	指示灯: 清理过滤器
	指示灯: 水箱排水
	指示灯: 烘干环节
	指示灯: 冷却环节
	指示灯: 防皱环节
	童锁启动
	选择错误
	程序运行时间
	定时烘干运行时间
	预约启动运行时间

## 5. 程序表

程序	烘干容量 (最大) 1)	特性 / 衣物类型 2)
定制 ☆	取决于 已保存程序	您可以自行设置程序配置并保存于本机内存 (请参阅“设置 - 定制 ☆”一章)。
棉麻	<b>7 kg</b>	棉麻织物。 /  
混合	<b>3kg</b>	棉和化纤织物。 低温程序。温热空气的轻柔程序。 /   
大件	<b>3kg</b>	床用织物, 例如单人或双人床单、 枕套、被套。 /   
化纤	<b>3.5 kg</b>	化纤和混纺纤维织物。 /   
节能	<b>7 kg</b>	用于烘干棉织物, 烘干程度为晾干 的程序。最大限度地节约能源。 /   
清新	<b>1kg</b>	对衣物进行焕新。
牛仔服	<b>4 kg</b>	休闲衣物, 如牛仔褲不同材质厚 度 (如领口, 袖口与缝合处) 的 运动衫。 /   

程序	烘干容量 (最大) 1)	特性 / 衣物类型 2)
运动服	2 kg	运动装、轻薄面料、超细纤维、聚酯纤维。 /   
防皱易熨	1 kg (或 5 件衬衫)	仅需要最少熨烫的易于护理的织物。各类型织物的烘干效果可能会有差别。将所洗衣物抖开, 然后再放入本机。当程序结束后, 请立即将衣物取出并晾干于衣架上。 /   
衬衫	1.5kg (或 7 件衬衫) /	仅需要最少熨烫的易于护理的织物。各类型织物的烘干效果可能会有差别。将所洗衣物抖开, 然后再放入本机。 当程序结束后, 请立即将衣物取出并晾干于衣架上。 /   
羊毛	1 kg	羊毛织物。轻柔烘干手洗羊毛织物。当程序完成时, 请立即取出衣物。
精细	4 kg	精细织物, 如粘胶纤维、人造棉、丙烯酸纤维及混纺织物。 /   



1) 烘干衣物的最大重量。

2) 有关织物标记的含义, 请参阅章节提示与技巧: 准备衣物。

## 6. 选项

### 6.1 烘干程度

此功能可提高烘干程度。共有 3 种程度:

-  特干
-  晾干
-  熨干

### 6.2 轻柔烘干

使用此选项, 您可以设置轻柔的低温烘干程序。此选项可用于织物标签上有  标志的织物 (如丙烯酸纤维、人造棉)。

### 6.3 防皱

烘干程序结束后的防皱环节可延长 60 分钟。此功能可减少褶皱。可以在防皱环节取出衣物。

## 6.4 定时烘干时间

您可以设置程序持续时间，最少 10 分钟，最多 2 小时。所需烘干时间与本机烘干衣物的数量有关。



我们建议您在烘干少量或单件衣物时设置较短的烘干时间。

## 6.5 选项表

程序 <sup>1)</sup>	烘干程度			轻柔烘干	除皱	烘干时间
定制 ☆	取决于已保存程序					
棉麻	■	■	■	■	■	■
混合	■	■			■	■
大件	■	■	■		■	
化纤	■	■	■	■	■	■
节能		■			■	
清新					■	
牛仔服	■	■		■	■	
运动服		■			■	
除皱易熨			■	■	■	
衬衫			■		■	
羊毛		■				
精细		■		■	■	

1) 可以与程序一起设置 1 个或多个选项。要启用或停用选项，请触摸相关按键。

## 7. 设置

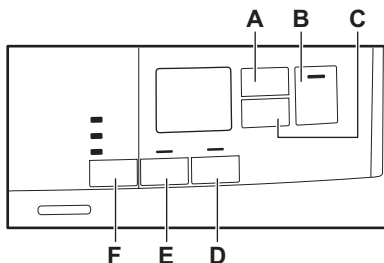

- A. 定时烘干触摸键
- B. 启动/暂停触摸键

- C. 预约触摸键
- D. 除皱触摸键
- E. 轻柔烘干触摸键
- F. 烘干程度触摸键

### 7.1 童锁功能

此选项可防止儿童在程序运行过程中玩耍本机。触摸按键处于锁定状态。

只有电源开/关按钮处于解锁状态。

## 启用童锁选项:

1. 按下电源开/关按钮启用本机。
2. 触摸并按住触摸按键 (D) 几秒钟。

童锁指示灯会亮起。

-  在程序运行过程中无法停用童锁选项。触摸并按住同一触摸按键直到童锁指示灯熄灭。本机开启 8 秒内无法使用童锁功能。

## 7.2 定制 ☆

您可以自行设置程序配置并保存于本机内存。

### 保存您的配置:

1. 按下电源开/关按钮启用本机
2. 设置程序和可用选项。
3. 按下 (E) 按钮几秒钟。

配置保存成功后将发出声音信号，显示屏上将显示一条消息。

### 启用已定制程序的方法:

1. 按下电源开/关按钮启用本机。
2. 使用程序旋钮以设置定制程序 ☆ 的位置。

将启动此前保存的程序配置和选项。

## 7.3 衣物剩余水分调节

-  每次进入“衣物剩余水分调节”模式，此前设置的剩余水分等级将变为下一级数值（例如此前设置的 - 2 - 将变为 - 1 -）。

更改默认剩余水分:

1. 按下电源开/关按钮启用本机。
2. 使用程序旋钮以设置任何程序。
3. 等待约 8 秒钟。
4. 同时触摸并按住 (E) 和 (D) 按钮。

以下其中一个指示灯会亮起。

- - 0 - 最高烘干程度
- - 1 - 较高烘干程度
- - 2 - 标准烘干程度

5. 再次同时触摸并按住 (E) 和 (D) 按钮，直到正确的指示灯亮起。

-  如果在设置剩余水分等级时，显示屏返回正常模式（将显示步骤 2 所选程序的时间），再次触摸并按住 (E) 和 (D) 按钮，进入“衣物剩余水分调节”模式（此前之前设置的剩余洗衣水分将变为下一级数值）。

6. 5 秒后显示屏返回正常模式。

## 7.4 水箱指示灯

默认情况下，水箱指示灯将点亮。当程序完成或需要排空水箱时，它都会点亮。

-  如果已安装排水套件（附加配件），本机水箱将自动排水。在这种情况下，我们建议您停用水箱指示灯。



## 停用水箱指示灯:

1. 按下电源开/关按钮启用本机。
  2. 等待约 8 秒钟。
  3. 同时触摸并按住 (A) 和 (C) 按钮。
- 显示器显示以下 2 种配置之一:
- 显示屏显示“关闭”。5 秒后显示屏返回正常模式。

- 显示屏显示“打开”。5 秒后显示屏返回正常模式。

## 7.5 蜂鸣器开/关

如需启用或停用声音信号，同时触摸并按住触摸按键 (E) 和 (F) 约 2 秒钟。

## 8. 首次使用前准备

在您首次使用本机前:

- 使用湿布清洁滚筒式干衣机的滚筒。

- 装入湿衣物，然后启动一个 1 小时的程序。

## 9. 日常使用

### 9.1 不预约启动程序

1. 准备衣物并装入本机。



#### 注意!

关闭本机门时，确保衣物没有夹在机门和橡胶封条之间。

2. 按下电源开/关按钮启用本机。
  3. 根据衣物类型选择适当的程序和选项。
- 显示屏显示程序持续时间。



选择棉麻程序时，您所看到的显示屏烘干时间是 5 kg 装载量和标准条件所需的时间。

实际烘干时间取决于衣物类型（数量和成分）、室温以及甩干脱水环节之后的衣物湿度。

4. 按下“启动/暂停”触摸按键。程序即会启动。

### 9.2 预约启动程序

1. 根据衣物类型选择适当的程序和选项。
2. 反复按下“预约启动”按键，直到显示屏显示您希望设置的预约启动时间。



您可以预约 30 分钟至 20 小时后启动。





3. 按下“启动/暂停”触摸按键。显示屏便会显示对预约启动的倒计时。倒计时结束后，程序将启动。

### 9.3 更换程序

1. 按“电源开/关”按钮停用本机
2. 按下电源开/关按钮启用本机。
3. 设置程序。

## 9.4 程序结束时

程序完成时:

- 将响起间歇的声音信号。
- 显示屏显示 。
- 指示灯  点亮。
- 指示灯  过滤器和  水箱可能点亮。
- 启动/暂停指示灯点亮。





如果设置了防皱选项，本机将继续运行防皱环节约 30 分钟或更长时间（请参阅选项 - 防皱一章）。

防皱环节可减少褶皱。

您可以在防皱环节完成之前将衣物取出。

为了达到更好的效果，我们建议您在该环节接近完成时再将衣物取出。

防皱环节完成时:

- 显示屏仍将显示 。
- 指示灯  熄灭。
- 指示灯  过滤器和  水箱仍然亮起。
- 启动/暂停指示灯熄灭。

1. 按下电源开/关按钮停用本机。
2. 打开机门。
3. 取出衣物。
4. 关闭机门。

 当程序完成后，请务必清洁过滤器并排空水箱。

## 9.5 待机功能

为减少能源消耗，此功能会自动停用本机:

- 如果您 5 分钟后仍未启动程序。
- 程序结束 5 分钟后。

# 10. 提示与技巧

## 10.1 准备衣物

- 拉上拉链。
- 系好被罩的摺扣。
- 请勿烘干领带或松散的丝带（例如裙带）。请在开始程序前，将其捆绑在一起。
- 取出口袋中的所有物品。
- 如果某件衣物有棉质内里，请将其翻出。棉质层必须朝外。
- 始终选择适合衣物类型的程序。

- 请勿将浅色与深色织物混在一起。
- 使用适合棉织物、针织物和针织品的程序来防止缩水。
- 烘干衣物量请勿超过程序章节规定和显示屏显示的最大烘干衣物量。
- 只能烘干适于滚筒烘干的衣物。请参阅衣物上的织物标签。
- 请勿将大件和小件衣物共同烘干。小件衣物可能会卷入大件衣物中，而无法被烘干。

织物标签	产品描述
	衣物适于滚筒烘干。
	衣物适于高温滚筒烘干。
	衣物仅适于低温滚筒烘干。
	衣物不适于滚筒烘干。

## 11. 保养与清洁

### 11.1 清洁过滤器

1.

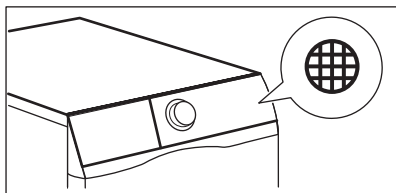

2.

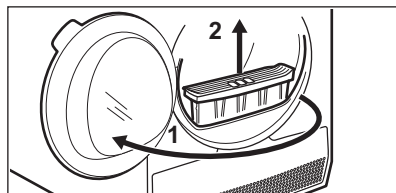

3.

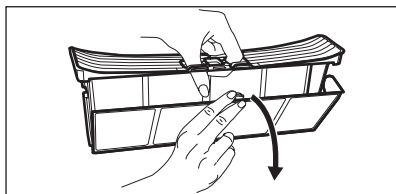

4.

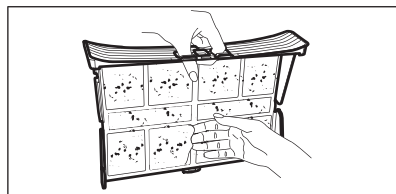

5. 1)

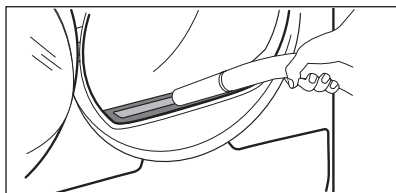

6.

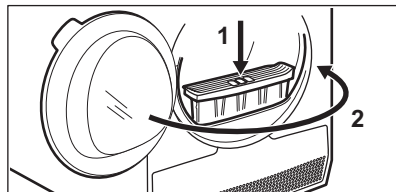

1) 必要时，请清除过滤器托和垫圈中的绒毛。您可以使用真空吸尘器来完成。

## 11.2 排空水箱

1.

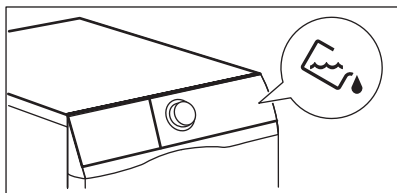

2.

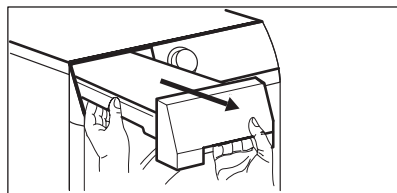

3.

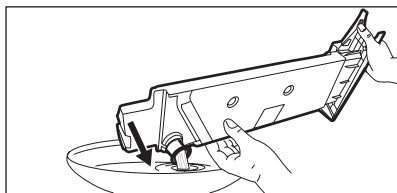

4.

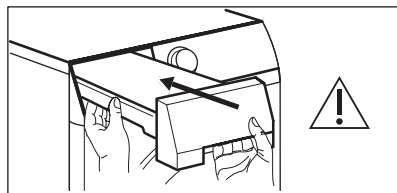

您可以用水箱里的水来代替蒸馏水（例如蒸汽熨烫）。使用水之前，请用过滤器清除污垢残留物。

## 11.3 清洁换热器

1.

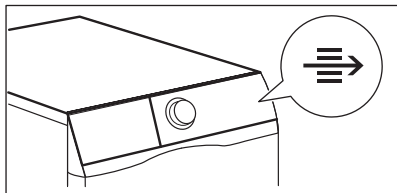

2.



3.

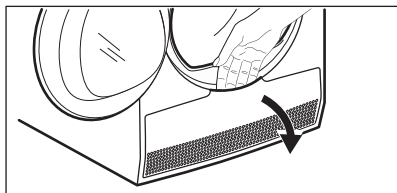

4.

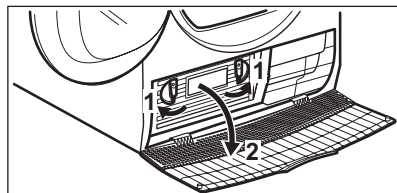

5.

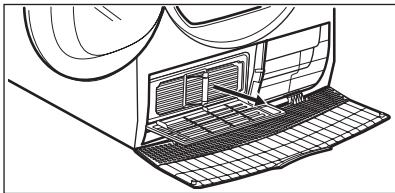

6.

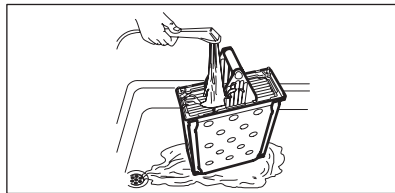

7.

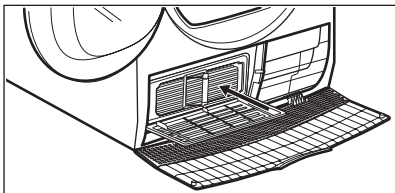

8.

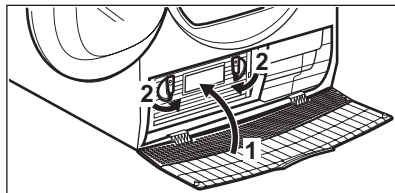

9.

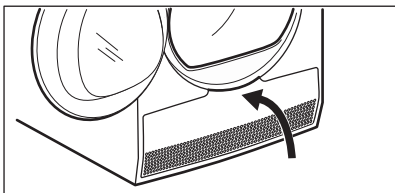

10.

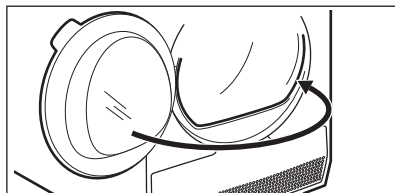

## 11.4 清洁滚筒



### 警告!

请在清洁前断开本机电源。

请使用标准中性肥皂洗涤剂清洁滚筒和滚筒提升筋的内表面。使用软布擦干清洁后的表面。



### 注意!

请勿使用磨砂型材料或钢丝球来清洁滚筒。

## 11.5 清洁控制面板和外壳

请使用标准中性肥皂洗涤剂清洁控制面板和外壳。

请使用湿布进行清洁。使用软布擦干清洁后的表面。



### 注意!

请勿使用家具清洁剂或可能造成腐蚀的清洁剂。

## 11.6 清洁气流槽

使用真空吸尘器清除气流槽中的绒毛。

## 12. 故障检修

问题	可行解决方案
无法启用本机。	确保电源插头与电源插座正确连接。
	检查保险丝盒中的保险丝（家用安装）。
程序无法启动。	按下“启动/暂停”按钮。
	确保机门处于关闭状态。
机门未关闭。	确保过滤器正确安装。
	确保衣物没有夹在机门和橡胶封条之间。
本机在运行过程中意外停机。	确保水箱是空的。按下启动/暂停按钮以再次启动程序。
	装载量过小，增加装载量或使用定时烘干程序。
程序持续时间过长或烘干效果不佳。 <sup>1)</sup>	确保衣物重量适合程序的持续时间。
	确保过滤器清洗干净。
	衣物过湿。使用洗衣机再次对衣物进行甩干脱水。
	确保室温高于 +5°C，低于 +35°C。最佳室温为 19°C 至 24°C。
	设置定时烘干程序或特干程序。 <sup>2)</sup>
显示屏显示  。	如果您想设置一个新程序，请关闭电源按键并重新启动本机。
	确保选项适合程序。
显示屏显示错误代码（例如 <b>E51</b> ）。	请关闭电源按键并重新启动本机。
	启动一个新程序。若问题再次出现，请联系服务中心。

1) 最长 5 小时后，程序将自动停止。

2) 在烘干大物件（如床单）时，部分区域可能仍然潮湿。

## 12.1 如果烘干效果不理想

- 设置的程序不正确。
- 过滤器堵塞。
- 换热器堵塞。
- 本机中的衣物太多。
- 滚筒脏污。
- 电导率传感器设置错误（参见“设置 - 衣物剩余水分调节”一章，以改进设置）。
- 气流槽堵塞。
- 室温过低或过高（最佳室温为 19°C 至 24°C）

## 13. 技术参数

高 x 宽 x 深	850 x 596 x 570 mm（最大 594 mm）
机门打开时的最大深度	1030 mm
机门打开时的最大宽度	950 mm
可调节高度	850 mm（+ 15 mm - 底脚调节）
最大干衣量	7 kg
电压	220-230 V
频率	50 Hz
总功率	2250 W
使用类型	家用
使用环境温度范围	+ 5°C 至 + 35°C
由防护罩确保的防止固体微粒和水分侵入防护等级，低压设备无水分侵入防护措施的情况除外。	<b>IPX4</b>

## 14. 快速指南

### 14.1 日常使用

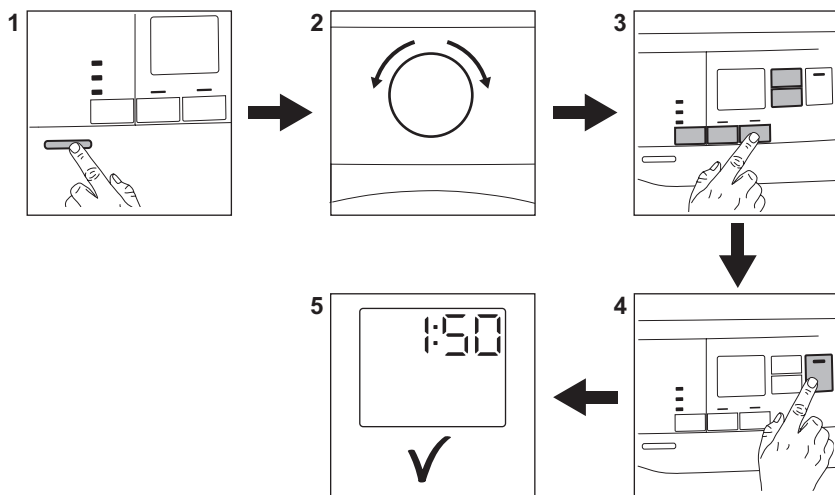

1. 按下“电源开/关”按钮打开本机。
2. 使用程序转盘设置程序。
3. 程序可以设置 1 个或多个特殊选项。  
要启用或停用一个选项，请触摸相关按钮。
4. 可触摸启动/暂停按钮启动该程序。
5. 电器启动。

### 14.2 清洁过滤器

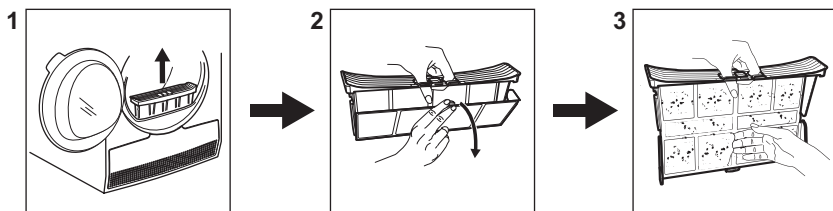

每次程序结束时， 过滤器符号将在显示屏上显示，您必须清理过滤器。





## 14.3 程序表

程序	烘干容量 (最大) 1)	特性 / 衣物类型2)
定制 ☆	取决于 已保存程序	您可以自行设置程序配置并保存于本机内存 (请参阅“设置 - 定制 ☆”一章)。
棉麻	7 kg	棉麻织物。 /  
混合	3kg	棉和化纤织物。 低温程序。温热空气的轻柔程序。 /   
大件	3kg	床用织物, 例如单人或双人床单、 枕套、被套。 /   
化纤	3.5 kg	化纤和混纺纤维织物。 /   
节能	7 kg	用于烘干棉织物, 烘干程度为晾干的 程序。最大限度地节约能源。 /   
清新	1kg	对衣物进行焕新。
牛仔服	4 kg	休闲衣物, 如牛仔裤、材质厚度 不同 (如领口、袖口与缝合处) 的 运动衫。 /   
运动服	2 kg	运动装、轻薄面料、超细纤维、聚 酯纤维。 /   
防皱易熨	1 kg (或 5 件衬衫)	仅需要最少熨烫的易于护理的织 物。各类型织物的烘干效果可能会有 差别。将所洗衣物抖开, 然后再 放入本机。当程序结束后, 请立即 将衣物取出并晾干于衣架上。 /   
衬衫	1.5kg (或 7 件衬衫) /	仅需要最少熨烫的免烫织物。各 类型织物的烘干效果可能会有差 别。将所洗衣物抖开, 然后再放 入本机。 当程序结束后, 请立即将衣物取出 并晾干于衣架上。 /   
羊毛	1 kg	羊毛织物。轻柔烘干手洗羊毛织物。 当程序完成时, 请立即取出衣物。
精细	4 kg	精细织物, 如粘胶纤维、人造棉、 丙烯酸纤维及混纺织物。 /   

1) 烘干衣物的最大重量。

2) 有关织物标记的含义, 请参阅章节提示与技巧: 准备衣物。

## 15. 环保信息

请回收再利用带有此符号的材料 。请将包装材料放在适当的回收箱中加以回收再利用。请回收再利用废弃电气和电子设备，为保护环境及人体健康贡献力量。请勿将标有符号  的电器与生活垃圾一同处置。请将该产品送到当地的回收站或联系市政部门。

确保某些有害化学品符合允许含量限度（符合 RoHS 标准）。

**RoHS**  
Compliant

## 16. 维修服务指南

### 伊莱克斯家用电器“三包”标准

为保证使用伊莱克斯家用电器的消费者获得满意的售后服务，本公司将严格按照《中华人民共和国消费者权益保护法》、《中华人民共和国产品质量法》、《部分商品修理更换退货责任规定》等法律法规

提供修理、更换、退货（简称“三包”）服务。

一、在“三包”有效期内，产品享受免费修理（包括材料费和工时费）；各产品的整机及主要部件的三包有效期如下：

名称	三包有效期 (年)		主要部件名称
	整机	主要部件	
电冰箱/红酒柜	1	3	压缩机，温控器，风扇电机，电磁阀，蒸发器，冷凝器，毛细管，过滤器，温控电路板，温度传感器
洗衣机/干衣机	1	3	电机，定时器，程控器，电容器，主控板，电机驱动板
空调	1	3	压缩机，风扇电机，温控器
吸油烟机	1	3	电机，主控板（含弱电和强电部分）
消毒柜	1	3	主控板，紫外线灯管，光波管，风机组件，门锁
燃气灶	1	3	燃气阀组件（阀体，电磁安全阀，热电偶，微动开关等），玻璃台面
嵌入式电灶	1	3	主控板，加热丝，温控装置
微波炉	1	2	主控板，电机，磁控管，定时器
嵌入式咖啡机	1	-	-
嵌入式烤箱/蒸箱	1	-	-
洗碗机	1	3	主控板，洗涤泵，加热器
暖灯/暖抽/ 真空抽屉	1	-	-

二、“三包”有效期自开具发票之日起计算。若产品实际交付时间晚于发票开具时间的，则“三包”有效期自实际交付日起计算。消费者享受“三包”应提供相应凭证，如：发票、收货凭证等。

三、对于为社会集团消费和生产消费购买的家用电器用户，其整机及主要部件“三包”有效期均为六个月。

四、本公司降价销售有外观瑕疵但不影响正常使用的家用电器，对其降价部位不再实行“三包”责任。

五、下列情况，不属于“三包”范畴之列，但可实行收费修理：

- ◆ 消费者搬运、安装、使用、维护、保管不当而损坏的。
- ◆ 自行或非经本公司授权维修中心拆修而造成损坏的。
- ◆ 无“三包”凭证及有效发票的。
- ◆ “三包”凭证型号与修理产品型号不符或涂改的。
- ◆ 因不可抗力力造成产品损坏的。

伊莱克斯服务热线：95105801

注意：本公司服务网络的名称、地址、邮编、电话、传真如有改动，本公司恕不另行通知并保留最终解释权。

## 产品保修卡

## 顾客信息

购买日期		发票号码	
顾客姓名		联系电话	
顾客地址及邮编			
产品名称		产品代码( PNC)	
产品型号		产品机号	
销售店名称		销售店电话	

## 维修记录

维修站名称 \_\_\_\_\_ 送修日 \_\_\_\_\_

故障内容 \_\_\_\_\_

故障原因 \_\_\_\_\_

维修内容 \_\_\_\_\_

维修技师签字 \_\_\_\_\_ 交验日期 \_\_\_\_\_

维修站名称 \_\_\_\_\_ 送修日 \_\_\_\_\_

故障内容 \_\_\_\_\_

故障原因 \_\_\_\_\_

维修内容 \_\_\_\_\_

维修技师签字 \_\_\_\_\_ 交验日期 \_\_\_\_\_

维修站名称 \_\_\_\_\_ 送修日 \_\_\_\_\_

故障内容 \_\_\_\_\_

故障原因 \_\_\_\_\_

维修内容 \_\_\_\_\_

维修技师签字 \_\_\_\_\_ 交验日期 \_\_\_\_\_

伊莱克斯（中国）电器有限公司

全国统一服务热线：95105801

伊莱克斯官方网站：<http://www.electrolux.com.cn>

## 产品中有害物质名称和含量

部件名称	有害物质					
	铅	汞	镉	六价铬	多溴联苯	多溴二苯醚
箱体 (含铰链)	X	O	O	O	O	O
烘干桶	O	O	O	O	O	O
泵, 电机及风扇	X	O	O	O	O	O
热泵系统 *	X	O	O	O	O	O
空气管道 (含滤网)	X	O	O	O	O	O
控制面板	X	O	O	O	O	O
机门 (含门锁)	X	O	O	O	O	O
冷凝器和水箱	O	O	O	O	O	O
顶盖	O	O	O	O	O	O
线束 (含电源线)	X	O	O	O	O	O

### 说明:

1. 本表格按照 SJ/T11364-2014 的规定编制。
2. “O” 表示该有害物质在该部件所有均质材料中的含量在 GB/T26572-2011 规定的限量要求以下;
3. “X” 表示该有害物质至少在该部件的某一均质材料中的含量超出 GB/T26572-2011 规定的限量要求;
4. 上表中打 X 的部件, 由于技术原因目前无法实现替代, 今后随着技术进步, 将实现替代或改进;
5. 上表中打 \* 号的表示不适用于全部型号, 具体以本产品实际配置为准;
6. 本产品在日常使用情况下, 环保使用期限为 15 年。





www.electrolux.com.cn



136959670-A-502018

