



Get the most out of your appliance



For quick access to manuals, how-to guides, support and more through our photo registration visit electrolux.com/register



Electrolux

WE'RE THINKING OF YOU

Thank you for purchasing an Electrolux appliance. You've chosen a product that brings with it decades of professional experience and innovation. Ingenious and stylish, it has been designed with you in mind. So whenever you use it, you can be safe in the knowledge that you'll get great results every time.

Welcome to Electrolux.

Visit our website to:



Get usage advice, brochures, trouble shooter, service and repair information:
www.electrolux.com/support



Register your product for better service:
www.registerelectrolux.com



Buy Accessories, Consumables and Original spare parts for your appliance:
www.electrolux.com/shop

CUSTOMER CARE AND SERVICE

Always use original spare parts.

When contacting our Authorised Service Centre, ensure that you have the following data available: Model, PNC, Serial Number.

The information can be found on the rating plate.

 Warning / Caution-Safety information

 General information and tips

 Environmental information

Subject to change without notice.

CONTENTS

1. SAFETY INFORMATION.....	5
1.1 Children and vulnerable people safety.....	5
1.2 General Safety.....	5
2. SAFETY INSTRUCTIONS.....	7
2.1 Installation.....	7
2.2 Electrical connection.....	8
2.3 Use.....	8
2.4 Care and cleaning.....	9
2.5 Steam Cooking.....	9
2.6 Internal lighting.....	10
2.7 Service.....	10
2.8 Disposal.....	10
3. PRODUCT DESCRIPTION.....	11
3.1 General overview.....	11
3.2 Accessories.....	11
4. HOW TO TURN OVEN ON AND OFF.....	13
4.1 Control panel.....	13
4.2 Display.....	13
5. BEFORE FIRST USE.....	15
5.1 Initial Cleaning	15
5.2 First connection.....	15
5.3 How to set: Water hardness.....	15
6. DAILY USE.....	17
6.1 How to set: Heating functions.....	17
6.2 How to set: Steamify - Steam heating function.....	17
6.3 How to set: Assisted Cooking.....	19
6.4 Heating functions.....	20
6.5 Notes on: Moist Fan Baking.....	22
7. CLOCK FUNCTIONS.....	23
7.1 Clock functions description.....	23
7.2 How to set: Clock functions.....	23
8. HOW TO USE: ACCESSORIES.....	26
8.1 Inserting accessories.....	26
8.2 Food Sensor.....	26
9. ADDITIONAL FUNCTIONS.....	29
9.1 How to save: Favourites.....	29
9.2 Automatic switch-off.....	29
9.3 Cooling fan.....	29
10. HINTS AND TIPS.....	30
10.1 Cooking recommendations.....	30
10.2 Moist Fan Baking.....	30
10.3 Moist Fan Baking - recommended accessories.....	31
10.4 Cooking tables for test institutes.....	31

CONTENTS

11. CARE AND CLEANING.....	33
11.1 Notes on cleaning.....	33
11.2 How to remove: Shelf supports	33
11.3 How to use: Steam Cleaning.....	34
11.4 Cleaning Reminder.....	34
11.5 How to use: Descaling.....	35
11.6 Descaling reminder.....	35
11.7 How to use: Rinsing.....	36
11.8 Drying reminder.....	36
11.9 How to use: Drying.....	36
11.10 How to use: Tank emptying.....	37
11.11 How to remove and install: Door.....	37
11.12 How to replace: Lamp.....	38
12. TROUBLESHOOTING.....	40
12.1 What to do if.....	40
12.2 How to manage: Error codes.....	40
12.3 Service data.....	41
13. ENERGY EFFICIENCY.....	42
13.1 Product Information and Product Information Sheet*.....	42
13.2 Energy saving.....	42
14. MENU STRUCTURE.....	44
14.1 Menu.....	44
14.2 Submenu for: Cleaning.....	44
14.3 Submenu for: Options.....	45
14.4 Submenu for: Setup.....	45
14.5 Submenu for: Service.....	46
15. IT'S EASY!.....	47
16. TAKE A SHORTCUT!.....	49

1. SAFETY INFORMATION

Before the installation and use of the appliance, carefully read the supplied instructions. The manufacturer is not responsible for any injuries or damage that are the result of incorrect installation or usage. Always keep the instructions in a safe and accessible location for future reference.

1.1 Children and vulnerable people safety

- This appliance can be used by children aged from 8 years and above and persons with reduced physical, sensory or mental capabilities or lack of experience and knowledge if they have been given supervision or instruction concerning the use of the appliance in a safe way and understand the hazards involved. Children of less than 8 years of age and persons with very extensive and complex disabilities shall be kept away from the appliance unless continuously supervised.
- Children should be supervised to ensure that they do not play with the appliance.
- Keep all packaging away from children and dispose of it appropriately.
- **WARNING:** Keep children and pets away from the appliance when it operates or when it cools down. Accessible parts become hot during use.
- If the appliance has a child safety device, it should be activated.
- Children shall not carry out cleaning and user maintenance of the appliance without supervision.

1.2 General Safety

- Only a qualified person must install this appliance and replace the cable.
- Do not use the appliance before installing it in the built-in structure.
- Disconnect the appliance from the power supply before carrying out any maintenance.

SAFETY INFORMATION

- If the mains power supply cable is damaged, it must be replaced by the manufacturer, its Authorised Service Centre or similarly qualified persons to avoid an electrical hazard.
- **WARNING:** Ensure that the appliance is switched off before replacing the lamp to avoid the possibility of electric shock.
- **WARNING:** The appliance and its accessible parts become hot during use. Care should be taken to avoid touching heating elements.
- Always use oven gloves to remove or put in accessories or ovenware.
- Use only the food sensor (core temperature sensor) recommended for this appliance.
- To remove the shelf supports first pull the front of the shelf support and then the rear end away from the side walls. Install the shelf supports in the opposite sequence.
- Do not use a steam cleaner to clean the appliance.
- Do not use harsh abrasive cleaners or sharp metal scrapers to clean the glass door since they can scratch the surface, which may result in shattering of the glass.

2. SAFETY INSTRUCTIONS

2.1 Installation

 **WARNING!**

Only a qualified person must install this appliance.

- Remove all the packaging.
- Do not install or use a damaged appliance.
- Follow the installation instructions supplied with the appliance.
- Always take care when moving the appliance as it is heavy. Always use safety gloves and enclosed footwear.
- Do not pull the appliance by the handle.
- Install the appliance in a safe and suitable place that meets installation requirements.
- Keep the minimum distance from other appliances and units.
- Before mounting the appliance, check if the oven door opens without restraint.
- The appliance is equipped with an electric cooling system. It must be operated with the electric power supply.
- The built-in unit must meet the stability requirements of DIN 68930.

Cabinet minimum height (Cabinet under the work-top minimum height)	444 (460) mm
Cabinet width	560 mm
Cabinet depth	550 (550) mm
Height of the front of the appliance	455 mm
Height of the back of the appliance	440 mm
Width of the front of the appliance	595 mm
Width of the back of the appliance	559 mm
Depth of the appliance	567 mm
Built in depth of the appliance	546 mm
Depth with open door	882 mm
Ventilation opening minimum size. Opening placed on the bottom rear side	560x20 mm
Mains supply cable length. Cable is placed in the right corner of the back side	1500 mm
Mounting screws	3.5x25 mm

SAFETY INSTRUCTIONS

2.2 Electrical connection

 **WARNING!**

Risk of fire and electric shock.

- All electrical connections should be made by a qualified electrician.
- The appliance must be earthed.
- Make sure that the parameters on the rating plate are compatible with the electrical ratings of the mains power supply.
- Always use a correctly installed shockproof socket.
- Do not use multi-plug adapters and extension cables.
- Make sure not to cause damage to the mains plug and to the mains cable. Should the mains cable need to be replaced, this must be carried out by our Authorised Service Centre.
- Do not let mains cables touch or come near the appliance door or the niche below the appliance, especially when it operates or the door is hot.
- The shock protection of live and insulated parts must be fastened in such a way that it cannot be removed without tools.
- Connect the mains plug to the mains socket only at the end of the installation. Make sure that there is access to the mains plug after the installation.
- If the mains socket is loose, do not connect the mains plug.
- Do not pull the mains cable to disconnect the appliance. Always pull the mains plug.
- Use only correct isolation devices: line protecting cut-outs, fuses (screw type fuses removed from the holder), earth leakage trips and contactors.
- The electrical installation must have an isolation device which lets you disconnect the appliance from the mains at all poles. The isolation device must have a contact opening width of minimum 3 mm.
- This appliance is supplied only with a main cable.

2.3 Use

 **WARNING!**

Risk of injury, burns and electric shock or explosion.

- This appliance is for household (indoors) use only.
- Do not change the specification of this appliance.
- Make sure that the ventilation openings are not blocked.
- Do not let the appliance stay unattended during operation.
- Deactivate the appliance after each use.
- Be careful when you open the appliance door while the appliance is in operation. Hot air can release.
- Do not operate the appliance with wet hands or when it has contact with water.
- Do not apply pressure on the open door.
- Do not use the appliance as a work surface or as a storage surface.
- Open the appliance door carefully. The use of ingredients with alcohol can cause a mixture of alcohol and air.
- Do not let sparks or open flames to come in contact with the appliance when you open the door.
- Do not put flammable products or items that are wet with flammable products in, near or on the appliance.

 **WARNING!**

Risk of damage to the appliance.

- To prevent damage or discoloration to the enamel:
 - do not put ovenware or other objects in the appliance directly on the bottom.
 - do not put aluminium foil directly on the bottom of cavity of the appliance.
 - do not put water directly into the hot appliance.
 - do not keep moist dishes and food in the appliance after you finish the cooking.
 - be careful when you remove or install the accessories.
- Discoloration of the enamel or stainless steel has no effect on the performance of the appliance.
- Use a deep pan for moist cakes. Fruit juices cause stains that can be permanent.
- This appliance is for cooking purposes only. It must not be used for other purposes, for example room heating.
- Always cook with the oven door closed.
- If the appliance is installed behind a furniture panel (e.g. a door) make sure the door is never closed when the appliance operates. Heat and moisture can build up behind a closed furniture panel and cause subsequent damage to the appliance, the housing unit or the floor. Do not close the furniture panel until the appliance has cooled down completely after use.

2.4 Care and cleaning

 **WARNING!**

Risk of injury, fire, or damage to the appliance.

- Before maintenance, deactivate the appliance and disconnect the mains plug from the mains socket.
- Make sure the appliance is cold. There is the risk that the glass panels can break.
- Replace immediately the door glass panels when they are damaged. Contact the Authorised Service Centre.
- Be careful when you remove the door from the appliance. The door is heavy!
- Clean regularly the appliance to prevent the deterioration of the surface material.
- Clean the appliance with a moist soft cloth. Use only neutral detergents. Do not use abrasive products, abrasive cleaning pads, solvents or metal objects.
- If you use an oven spray, follow the safety instructions on its packaging.

2.5 Steam Cooking

 **WARNING!**

Risk of burns and damage to the appliance.

- Released Steam can cause burns:
 - Be careful when you open the appliance door when the function is activated. Steam can release.
 - Open the appliance door with care after the steam cooking operation.

SAFETY INSTRUCTIONS

2.6 Internal lighting

 **WARNING!**

Risk of electric shock.

- Concerning the lamp(s) inside this product and spare part lamps sold separately: These lamps are intended to withstand extreme physical conditions in household appliances, such as temperature, vibration, humidity, or are intended to signal information about the operational status of the appliance. They are not intended to be used in other applications and are not suitable for household room illumination.
- Use only lamps with the same specifications.

2.7 Service

- To repair the appliance contact the Authorised Service Centre.
- Use original spare parts only.

2.8 Disposal

 **WARNING!**

Risk of injury or suffocation.

- Contact your municipal authority for information on how to dispose of the appliance.
- Disconnect the appliance from the mains supply.
- Cut off the mains electrical cable close to the appliance and dispose of it.
- Remove the door catch to prevent children or pets from becoming trapped in the appliance.

3. PRODUCT DESCRIPTION

3.1 General overview

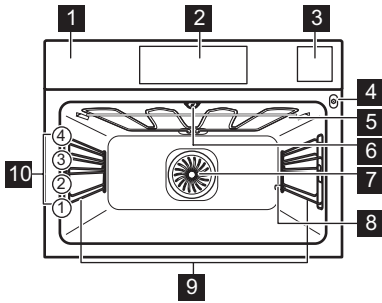

- 1 Control panel
- 2 Display
- 3 Water drawer
- 4 Socket for the food sensor
- 5 Heating element
- 6 Lamp
- 7 Fan
- 8 Descaling pipe outlet
- 9 Shelf support, removable
- 10 Shelf positions

3.2 Accessories

Wire shelf

For cookware, cake tins, roasts.

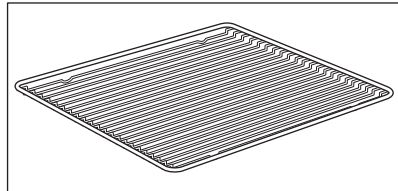

Baking tray

For cakes and biscuits.

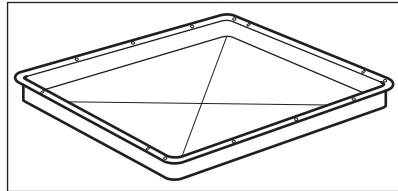

Grill- / Roasting pan

To bake and roast or as a pan to collect fat.

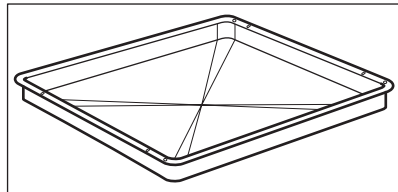

Food sensor

To measure the temperature inside food.

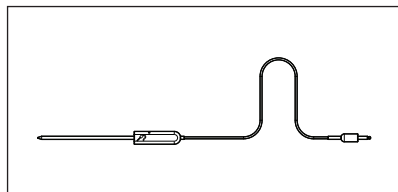

PRODUCT DESCRIPTION

Steam set

One unperforated and one perforated food container.

The steam set drains the condensing water away from the food during steam cooking. Use it to prepare vegetables, fish, chicken breast. The set is not suitable for food that needs to soak in the water e.g. rice, polenta, pasta.

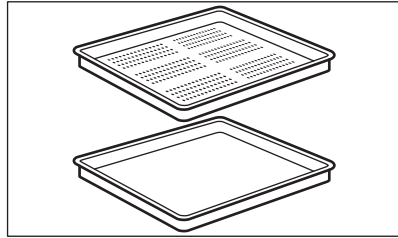

4. HOW TO TURN OVEN ON AND OFF

4.1 Control panel

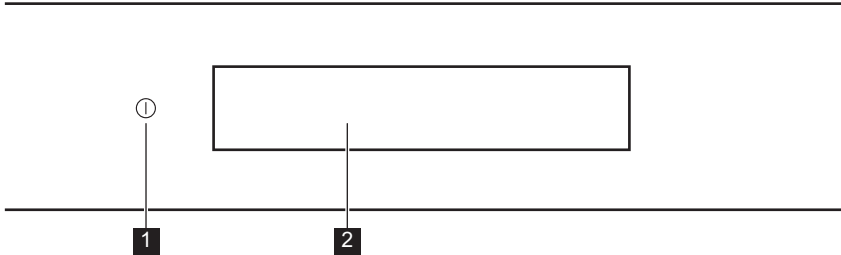

1	ON / OFF	Press and hold to turn the oven on and off.
2	Display	Shows the current settings of the oven.









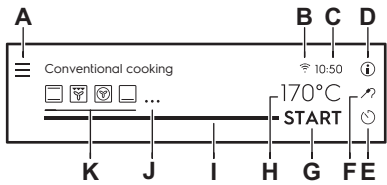



Press	Move	Press and hold
Touch the surface with fingertip.	Slide fingertip over the surface.	Touch the surface for 3 seconds.

4.2 Display

	After turning on, the display shows the main screen with heating functions and the default temperature.
	If you do not use the oven for 2 minutes, the display goes to standby.
	When you cook, the display shows the set functions and other available options.

HOW TO TURN OVEN ON AND OFF

 <p>The diagram shows an oven control panel with the following labels:</p> <ul style="list-style-type: none"> A: Menu / Back button (top left) B: Wi-Fi button (top right) C: Time of day button (top right) D: Information button (top right) E: Timer button (bottom right) F: Food sensor button (bottom right) G: START/STOP button (bottom center) H: Temperature button (bottom center) I: Progress bar / Slider (bottom center) J: More button (bottom left) K: Heating functions button (bottom left) 	<p>The display with the maximum number of functions set.</p> <ul style="list-style-type: none"> A. Menu / Back B. Wi-Fi (selected models only) C. Time of day D. Information E. Timer F. Food sensor (selected models only) G. START/STOP H. Temperature I. Progress bar / Slider J. More K. Heating functions
--	---



<h2>Display indicators</h2>				
<h3>Basic indicators - to navigate on the display.</h3>				
 To confirm the selection / setting.	 To confirm the selection / setting or to go one level back in the menu.	 To go one level back in the menu / undo the last action.	 To turn the options on and off.	
<h3>Sound alarm function indicators - when the set time of cooking ends, the signal sounds.</h3>				
 The function is on.	 The function is on. Cooking stops automatically.	 Sound alarm is off.		
<h3>Timer indicators</h3>				
 To set the function: Delayed start.	 To cancel the setting.	 The timer starts after closing the oven door.	 The timer starts when the oven reaches the set temperature.	 The timer starts when cooking starts.

5. BEFORE FIRST USE

WARNING!

Refer to Safety chapters.

5.1 Initial Cleaning

		
Step 1	Step 2	Step 3
Remove all accessories and removable shelf supports from the oven.	Clean the oven and the accessories with a soft cloth, warm water and a mild detergent.	Place the accessories and the removable shelf supports in the oven.

5.2 First connection





The display shows welcome message after the first connection.

You have to set: Language, Display brightness, Buzzer volume, Water hardness, Time of day.

5.3 How to set: Water hardness





When you connect the oven to the mains you have to set the water hardness level.

Use the test paper supplied with the steam set.

			
Step 1	Step 2	Step 3	Step 4
Put the test paper into water for about 1 sec. Do not put the test paper under running water.	Shake the test paper to remove the excess of water.	After 1 min, check water hardness with the table below.	Set the water hardness level: Menu / Settings / Setup / Water hardness.
<p> The colours of the test paper continue to change. Do not check water hardness later than 1 min after test.</p>			
<p>You can change the water hardness level in the menu: Settings / Setup / Water hardness.</p>			

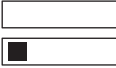
The table shows water hardness range (dH) with the corresponding level of Calcium deposit and the water classification. Adjust the water hardness level according to the table.

BEFORE FIRST USE

Water hardness		Test paper	Calcium deposit (mmol/l)	Calcium deposit (mg/l)	Water classification
Level	dH				
1	0 - 7		0 - 1.3	0 - 50	soft
2	8 - 14		1.4 - 2.5	51 - 100	moderately hard
3	15 - 21		2.6 - 3.8	101 - 150	hard
4	≥22		≥ 3.9	≥151	very hard

When the tap water hardness level is 4, fill the water drawer with still bottled water.

6. DAILY USE

WARNING!

Refer to Safety chapters.

6.1 How to set: Heating functions

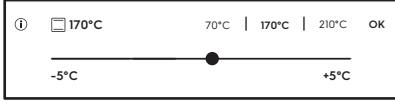
Step 1	Turn on the oven.
Step 2	Select a heating function. The display shows the default heating functions. To see more heating functions press: ● ● ● .
Step 3	Press: °C. The display shows the temperature settings. 
Step 4	Move the finger on the slider to set the temperature.
Step 5	Press: OK.
Step 6	Press: START . Food Sensor - you can plug the sensor at any time before or during cooking.
STOP - press to turn off the heating function.	
Step 7	Turn off the oven.

Take a shortcut!

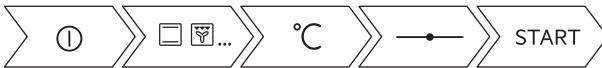

6.2 How to set: Steamify - Steam heating function

Step 1	Turn on the oven.
Step 2	Press  . Set the steam heating function.
Step 3	Press: °C. The display shows the temperature settings.

DAILY USE

Step 4	Set the temperature. Type of the steam heating function depends on the set temperature.
Steam for Steaming 50 - 100 °C	For steaming vegetables, grains, legumes, seafood, terrines and spoon desserts.
Steam for Stewing 105 - 130 °C	For cooking stewed and braised meat or fish, bread and poultry, as well as cheesecakes and casseroles.
Steam for Gentle Crisping 135 - 150 °C	For meat, casseroles, stuffed vegetables, fish and gratin. Owing to the combination of steam and heat the meat gets a juicy and tender texture along with a crusty surface. If you set the timer, grill function turns on automatically in the last minutes of the cooking process to give dish a gentle gratin.
Steam for Baking and Roasting 155 - 230 °C	For roasted and baked dishes meat, fish, poultry, filled puff pastry, tarts, muffins, gratin, vegetables and bakery dishes. If you set the timer and put the food on the first level, bottom heat function turns on automatically in the last minutes of the cooking process to give dish a crispy bottom.
Step 5	Press: OK.
Step 6	Press the cover of the water drawer to open it.
Step 7	<p>Fill the water drawer with cold water to the maximum level (around 950 ml) until the signal sounds or the display shows the message. The water supply is sufficient for approximately 50 min. Do not fill the water drawer over its maximum capacity. There is a risk of water leakage, overflow and furniture damage.</p> <div style="border: 1px solid black; padding: 5px; margin-top: 10px;"> <p> WARNING! Use only cold tap water. Do not use filtered (demineralised) or distilled water. Do not use other liquids. Do not pour flammable or alcoholic liquids into the water drawer.</p> </div>
Step 8	Push the water drawer to its initial position.
Step 9	Press: START. Steam appears after approximately 2 min. When the oven reaches the set temperature, the signal sounds.

Step 10	When the water drawer runs out of water, the signal sounds. Refill the water drawer. The signal sounds at the end of the cooking time.
Step 11	Turn off the oven.
Step 12	Empty the water drawer after cooking ends. Refer to "Care and Cleaning" chapter, Tank emptying.
Step 13	Residual water can condensate in the cavity. After cooking, carefully open the oven door. When the oven is cold, dry the cavity with a soft cloth.

Take a shortcut!

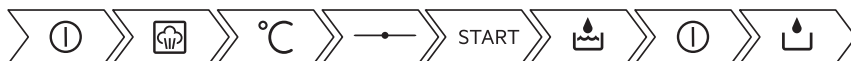

6.3 How to set: Assisted Cooking

Every dish in this submenu has a recommended function and temperature. You can adjust the time and the temperature.

For some of the dishes you can also cook with:

- Food Sensor

The degree to which a dish is cooked:

- Rare or Less
- Medium
- Well done or More









Step 1	Turn on the oven.
Step 2	Press:
Step 3	Press: . Enter: Assisted Cooking.
Step 4	Choose a dish or a food type.
Step 5	Press: START .

Take a shortcut!











6.4 Heating functions







STANDARD

Heating function	Application
 Grill	To grill thin pieces of food and to toast bread.
 Turbo Grilling	To roast large meat joints or poultry with bones on one shelf position. To make gratins and to brown.
 True Fan Cooking	To bake on up to three shelf positions at the same time and to dry food. Set the temperature 20 - 40 °C lower than for Conventional Cooking.
 Frozen Foods	To make convenience food (e.g., french fries, potato wedges or spring rolls) crispy.
 Conventional Cooking	To bake and roast food on one shelf position.
 Pizza Function	To bake pizza. To make intensive browning and a crispy bottom.
 Bottom Heat	To bake cakes with crispy bottom and to preserve food.
 Steamify	Use steam for steaming, stewing, gentle crisping, baking and roasting.

SPECIALS

Heating function	Application
 <p data-bbox="141 336 253 360">Preserving</p>	To preserve vegetables (e.g., pickles).
 <p data-bbox="135 456 258 480">Dehydrating</p>	To dry sliced fruit, vegetables and mushrooms.
 <p data-bbox="118 576 269 600">Plate Warming</p>	To preheat plates for serving.
 <p data-bbox="157 695 236 719">Defrost</p>	To defrost food (vegetables and fruit). The defrosting time depends on the amount and size of the frozen food.
 <p data-bbox="146 815 247 839">Au Gratin</p>	For dishes such as lasagna or potato gratin. To make gratins and to brown.
 <p data-bbox="124 935 269 959">Slow Cooking</p>	To prepare tender, succulent roasts.
 <p data-bbox="135 1054 258 1078">Keep Warm</p>	To keep food warm.
 <p data-bbox="107 1174 286 1198">Moist Fan Baking</p>	This function is designed to save energy during cooking. When you use this function, the temperature in the cavity may differ from the set temperature. The residual heat is used. The heating power may be reduced. For more information refer to "Daily Use" chapter, Notes on: Moist Fan Baking.

STEAM

Heating function	Application
 <p>Steam Regenerating</p>	<p>Food reheating with steam prevents surface drying. Heat is distributed in a gentle and even way, which allows to recover taste and aroma of food as just prepared. This function can be used to reheat food directly on a plate. You can reheat more than one plate at the same time, using different shelf positions.</p>
 <p>Bread Baking</p>	<p>Use this function to prepare bread and bread rolls with a very good professional-like result in terms of crispiness, colour and crust gloss.</p>
 <p>Dough Proving</p>	<p>To speed up the rising of the yeast dough. It prevents dough surface from drying and keeps the dough elastic.</p>
 <p>Full Steam</p>	<p>For steaming vegetables, side dishes, fish</p>
 <p>Humidity High</p>	<p>The function is suitable for cooking delicate dishes like custards, flans, terrines and fish.</p>
 <p>Humidity Low</p>	<p>The function is suitable for meat, poultry, oven dishes and casseroles. Thanks to the combination of steam and heat, meat gets a tender and juicy texture along with a crusty surface.</p>

6.5 Notes on: Moist Fan Baking

This function was used to comply with the energy efficiency class and ecodesign requirements according to EU 65/2014 and EU 66/2014. Tests according to EN 60350-1.

The oven door should be closed during cooking so that the function is not interrupted and the oven operates with the highest energy efficiency possible.



When you use this function the lamp automatically turns off after 30 sec.

For the cooking instructions refer to "Hints and tips" chapter, Moist Fan Baking. For general energy saving recommendations refer to "Energy Efficiency" chapter, Energy Saving.



7. CLOCK FUNCTIONS

7.1 Clock functions description

Clock function	Application
Cooking time	To set the length of cooking. Maximum is 23 h 59 min.
Start criteria	To set when the timer starts counting.
End action	To set what happens when the timer ends counting.
Delayed start	To postpone the start and / or end of cooking.
Time extension	To extend cooking time.
Reminder	To set a countdown. Maximum is 23 h 59 min. This function has no effect on the operation of the oven.
Uptimer	Monitors how long the function operates. Uptimer - you can turn it on and off.

Start criteria	Comment
-	The timer starts when you turn it on.
	The timer starts after closing the door.
	The timer starts when cooking starts.
	The timer starts when the oven reaches the set temperature.

7.2 How to set: Clock functions



How to set the clock	
Step 1	Press: 
Step 2	Press: Settings / Setup / Time of day.
Step 3	Slide and press to set the clock. Press:  or  .

CLOCK FUNCTIONS

How to set cooking time	
Step 1	Choose a heating function and set the temperature.
Step 2	Press:  .
Step 3	Slide and press to set the clock. Press: OK . Timer starts counting down immediately.

Take a shortcut!





How to choose cooking start / end option	
Step 1	Choose a heating function and set the temperature.
Step 2	Press:  .
Step 3	Press: ● ● ● .
Step 4	Press: Start criteria / End action.
Step 5	Choose the preferred: Start criteria / End action.
Step 6	Press: OK or  .

How to delay start and end of cooking	
Step 1	Press:  .
Step 2	Slide and press to set the clock. Press: OK .

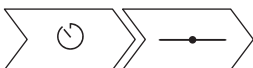
Take a shortcut!



How to delay start without setting the end of cooking	
Step 1	Set the heating function and the temperature.
Step 2	Press:  .
Step 3	Press: ● ● ● .
Step 4	Press: Delayed start.
Step 5	Choose the value. Press: OK.

How to set extra time	
When 10% of cooking time is left and the food seems not to be ready, you can extend cooking time. You can also change the oven function.	
Step 1	Press the preferred time icon to extend cooking time.
Step 2	Also, you can select the preferred heating function to change it.
What if it's better to change extra time?	
It's possible to reset extra time.	
Step 1	Press:  .
Step 2	Choose the value on the slider or press one of the preferred time icons to set the time.
Step 3	Press: OK.

How to change timer settings	
Step 1	Choose the value on the slider or press the preferred time value to change the timer value.
Step 2	Press: OK.
You can change the set time during cooking at any time.	

8. HOW TO USE: ACCESSORIES

8.1 Inserting accessories

A small indentation at the top increases safety. The indentations are also anti-tip devices. The high rim around the shelf prevents cookware from slipping of the shelf.

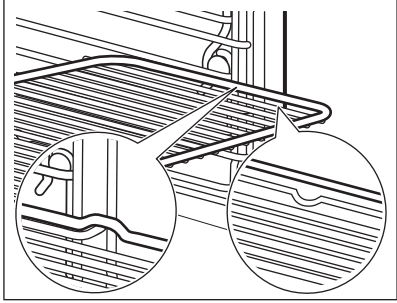
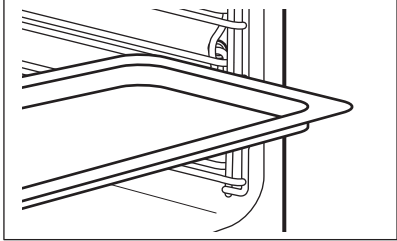
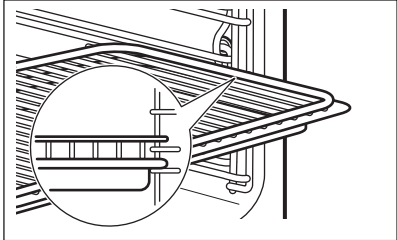
<p>Wire shelf: Push the shelf between the guide bars of the shelf support and make sure that the feet point down.</p>	
<p>Baking tray / Deep pan: Push the tray between the guide bars of the shelf support.</p>	
<p>Wire shelf, Baking tray / Deep pan: Push the tray between the guide bars of the shelf support and the wire shelf on the guide bars above.</p>	

8.2 Food Sensor

Food Sensor- measures the temperature inside the food. You can use it with every heating function.



There are two temperatures to be set:	
<p>°C The oven temperature: minimum 120 °C.</p>	<p> The core temperature.</p>

For the best cooking results:

Ingredients should be at room temperature.	Do not use it for liquid dishes.	During cooking it must remain in the dish.
--	----------------------------------	--

The oven calculates an approximate end of cooking time. It depends on the quantity of food, the set oven function and the temperature.

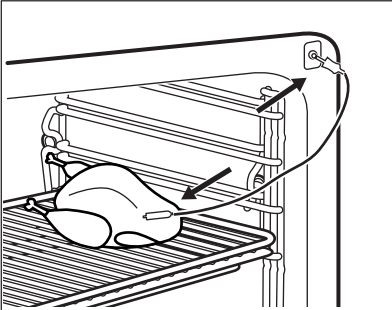
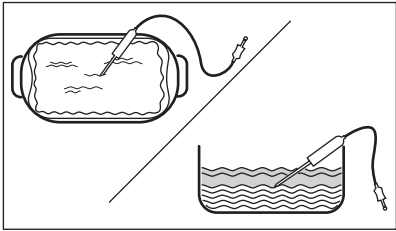
How to use: Food Sensor

Step 1	Turn on the oven.	
Step 2	Set a heating function and, if necessary, the oven temperature.	
Step 3	Insert: Food Sensor.	
Meat, poultry and fish	Casserole	
<p>Insert the tip of Food Sensor into the centre of meat, fish, in the thickest part if possible. Make sure that at least 3/4 of Food Sensor is inside of the dish.</p>	<p>Insert the tip of Food Sensor exactly in the centre of the casserole. Food Sensor should be stabilized in one place during baking. Use a solid ingredient to achieve that. Use the rim of the baking dish to support the silicone handle of Food Sensor. The tip of Food Sensor should not touch the bottom of a baking dish.</p>	
		
Step 4	<p>Plug Food Sensor into the socket at the front of the oven. The display shows the current temperature of: Food Sensor.</p>	
Step 5	<p> - press to set the core temperature of the sensor.</p>	

HOW TO USE: ACCESSORIES

Step 6	<ul style="list-style-type: none">● ● ● - press to set the preferred option:• Sound alarm - when food reaches the core temperature, the signal sounds.• Sound alarm and stop cooking - when food reaches the core temperature, the signal sounds and the oven stops.• Just show temperature - the display shows the current core temperature.
Step 7	Select the option and press: OK or <
Step 8	Press: START . When food reaches the set temperature, the signal sounds. You can choose to stop or to continue cooking to make sure the food is well done.
Step 9	Remove Food Sensor plug from the socket and remove the dish from the oven. <div style="border: 1px solid black; padding: 5px;"><p> WARNING! There is a risk of burns as Food Sensor becomes hot. Be careful when you unplug it and remove it from the food.</p></div>



Take a shortcut!



9. ADDITIONAL FUNCTIONS



9.1 How to save: Favourites

You can save your favourite settings, such as the heating function, the cooking time, the temperature or the cleaning function. You can save 3 favourite settings.

Step 1	Turn on the oven.
Step 2	Select the preferred setting.
Step 3	Press:  . Select: Favourites.
Step 4	Select: Save current settings.
Step 5	Press + to add the setting to the list of: Favourites. Press OK.
 - press to reset the setting.  - press to cancel the setting.	

9.2 Automatic switch-off

For safety reasons the oven turns off after some time, if a heating function works and you do not change any settings.

 (°C)	 (h)
30 - 115	12.5
120 - 195	8.5
200 - 230	5.5

The Automatic switch-off does not work with the functions: Light, Food sensor, End time, Slow Cooking.

9.3 Cooling fan

When the oven operates, the cooling fan turns on automatically to keep the surfaces of the oven cool. If you turn off the oven, the cooling fan can continue to operate until the oven cools down.

10. HINTS AND TIPS

10.1 Cooking recommendations













The temperature and cooking times in the tables are guidelines only. They depend on the recipes and the quality and quantity of the ingredients used.

Your oven may bake or roast differently to the oven you had before. The tables below show recommended settings for temperature, cooking time and shelf position for specific types of the food. If you cannot find the settings for a special recipe, look for the similar one.

For more cooking recommendations refer to cooking tables on our website. To find the Cooking Hints check the PNC number on the rating plate on the front frame of the oven cavity.





10.2 Moist Fan Baking

		 (°C)		 (min)
Sweet rolls, 16 pieces	baking tray or dripping pan	180	2	20 - 30
Swiss Roll	baking tray or dripping pan	180	1	20 - 30
Sponge flan base	flan base tin on wire shelf	180	1	25 - 35
Poached fish, 0.3 kg	baking tray or dripping pan	180	2	15 - 25
Whole fish, 0.2 kg	baking tray or dripping pan	180	2	20 - 30
Macaroons, 24 pieces	baking tray or dripping pan	160	1	30 - 40
Muffins, 12 pieces	baking tray or dripping pan	180	1	25 - 35
Savory pastry, 20 pieces	baking tray or dripping pan	180	1	25 - 35
Short crust biscuits, 20 pieces	baking tray or dripping pan	160	1	25 - 35

		 (°C)		 (min)
Tartlets, 8 pieces	baking tray or dripping pan	180	1	15 - 25
Vegetables, poached, 0.4 kg	baking tray or dripping pan	180	2	30 - 40

10.3 Moist Fan Baking - recommended accessories



Use the dark and non-reflective tins and containers. They have better heat absorption than the light colour and reflective dishes.

			
Pizza pan	Baking dish	Ramekins	Flan base tin
Dark, non-reflective 28 cm diameter	Dark, non-reflective 26 cm diameter	Ceramic 8 cm diameter, 5 cm height	Dark, non-reflective 28 cm diameter

10.4 Cooking tables for test institutes



Information for test institutes

Tests according to EN 60350 and IEC 60350.

<p>Use the function: Full Steam. Use the second shelf position. Put the baking tray on the first shelf position. Set the temperature to 100 °C.</p>			
STEAM FUNCTION	 Container (Gastro-norm)	 (kg)	 (min)
Broccoli, preheat the empty oven	1 x 1/2 perforated	0.3	8 - 9

HINTS AND TIPS

Use the function: Full Steam.
Use the second shelf position.
Put the baking tray on the first shelf position.
Set the temperature to 100 °C.

STEAM FUNCTION	 Container (Gastro-norm)	 (kg)	 (min)
Broccoli, preheat the empty oven	1 x 1/2 perforated	max.	10 - 11
Peas, frozen	1 x 1/2 perforated	2	Until the temperature in the coldest spot reaches 85 °C.

11. CARE AND CLEANING

⚠ WARNING!

Refer to Safety chapters.

11.1 Notes on cleaning

 <p>Cleaning Agents</p>	Clean the front of the oven with a soft cloth with warm water and a mild detergent.
	Use a cleaning solution to clean metal surfaces.
	Clean stains with a mild detergent.

 <p>Everyday Use</p>	Clean the cavity after each use. Fat accumulation or other residue may cause fire.
	Do not store the food in the oven for longer than 20 minutes. Dry the cavity with a soft cloth after each use.

 <p>Accessories</p>	Clean all accessories after each use and let them dry. Use a soft cloth with warm water and a mild detergent. Do not clean the accessories in a dishwasher.
	Do not clean the non-stick accessories using abrasive cleaner or sharp-edged objects.

11.2 How to remove: Shelf supports

Remove the shelf supports to clean the oven.

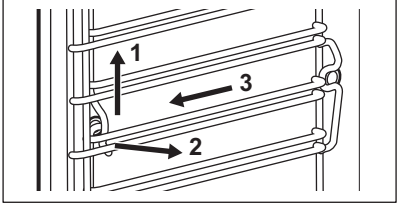
Step 1	Turn off the oven and wait until it is cold.	
Step 2	Carefully pull the shelf supports up and out of the front catch.	
Step 3	Pull the front end of the shelf support away from the side wall.	
Step 4	Pull the supports out of the rear catch.	

Install the shelf supports in the opposite sequence.

CARE AND CLEANING

11.3 How to use: Steam Cleaning

Before you start:		
Turn off the oven and wait until it is cold.	Remove all accessories and removable shelf supports.	Clean the bottom of the cavity and the inner door glass with a soft cloth with warm water and a mild detergent.

Step 1	Fill the water drawer to the maximum level until the signal sounds or the display shows the message.
---------------	--

Step 2	Select: Menu / Cleaning.
---------------	--------------------------

Function	Description	Duration
Steam Cleaning	Light cleaning	30 min
Steam Cleaning Plus	Normal cleaning Spray the cavity with a detergent.	75 min

Step 3	Turn on the function. Follow the instruction on the display. The signal sounds when the cleaning ends.
---------------	--

Step 4	Press any symbol to turn off the signal.
---------------	--

 When this function works, the lamp is off.

When the cleaning ends:		
Turn off the oven.	When the oven is cold, dry the cavity with a soft cloth.	Leave the oven door open and wait until the cavity is dry.

11.4 Cleaning Reminder

When the reminder appears, cleaning is recommended.
Use the function: Steam Cleaning Plus.
You can enable and disable the reminder in the menu: Setup.

11.5 How to use: Descaling

Before you start:		
Turn off the oven and wait until it is cold.	Remove all accessories.	Make sure that the water drawer is empty.

Duration of the first part: around 100 min	
Step 1	Place the deep pan on the first shelf position.
Step 2	Pour 250 ml of the descaling agent in the water drawer.
Step 3	Fill the remaining part of the water drawer with water to the maximum level until the signal sounds or the display shows the message.
Step 4	Select: Menu / Cleaning.
Step 5	Turn on the function and follow the instruction on the display. The first part of descaling starts.
Step 6	After the first part is over, empty the deep pan and put it back on the first shelf position.

Duration of the second part: around 35 min	
Step 7	Fill the remaining part of the water drawer with water to the maximum level until the signal sounds or the display shows the message.
Step 8	When the function ends, remove the deep pan.
 When this function works, the lamp is off.	

When descaling ends:		
Turn off the oven.	When the oven is cold, dry the cavity with a soft cloth.	Leave the oven door open and wait until the cavity is dry.
 If some limestone residue remains in the oven after descaling, the display prompts to repeat the procedure.		

11.6 Descaling reminder

There are two reminders which prompt you to descale the oven. You cannot disable the descaling reminder.

CARE AND CLEANING

Type	Description
Soft reminder	Recommends you to descale the oven.
Hard reminder	Obligates you to descale the oven. If you do not descale the oven when the hard reminder is on, the steam functions are disabled.

 These reminders activate each time you turn off the oven.

11.7 How to use: Rinsing

Before you start:	
Turn off the oven and wait until it is cold.	Remove all accessories.

Step 1	Place the deep pan on the first shelf position.
Step 2	Fill the water drawer with water to the maximum level until the signal sounds or the display shows the message.
Step 3	Select: Menu / Cleaning / Rinsing. Duration: around 30 min
Step 4	Turn on the function and follow the instruction on the display.
Step 5	When the function ends, remove the deep pan.

 When this function works, the lamp is off.

11.8 Drying reminder

After cooking with a steam heating function the display prompts to dry the oven. Press YES to dry the oven.

11.9 How to use: Drying

Use it after cooking with a steam heating function or steam cleaning to dry the cavity.

Step 1	Make sure the oven is cold.
Step 2	Remove all accessories.
Step 3	Select the menu: Cleaning / Drying.
Step 4	Follow the instructions on the screen.

11.10 How to use: Tank emptying

Use it after cooking with steam heating function to remove the residual water from the water drawer.

Before you start:	
Turn off the oven and wait until it is cold.	Remove all accessories.

Step 1	Place the deep pan on the first shelf position.
Step 2	Select: Menu / Cleaning / Tank emptying. Duration: 6 min
Step 3	Turn on the function and follow the instruction on the display.
Step 4	When the function ends, remove the deep pan.
<p> When this function works, the lamp is off.</p>	

11.11 How to remove and install: Door

You can remove the door and the internal glass panels to clean it. The number of glass panels is different for different models.

 **WARNING!**

The door is heavy.

 **CAUTION!**

Carefully handle the glass, especially around the edges of the front panel. The glass can break.

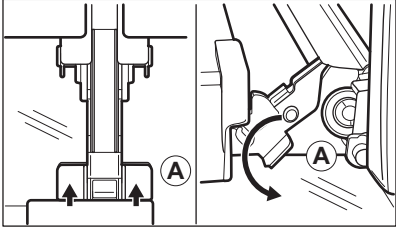
Step 1	Fully open the door.	
Step 2	Lift and press the clamping levers (A) on the two door hinges.	
Step 3	Close the oven door to the first opening position (approximately 70° angle). Hold the door at both sides and pull it away from the oven at an upwards angle. Put the door with the outer side down on a soft cloth on a stable surface.	

CARE AND CLEANING

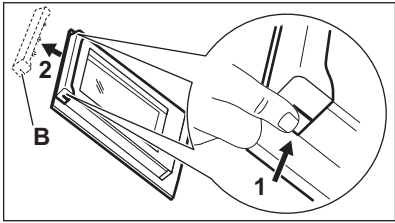
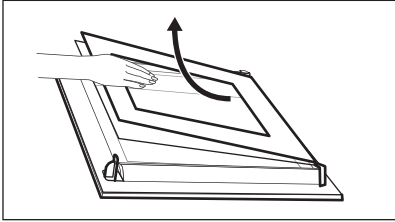
<p>Step 4</p>	<p>Hold the door trim (B) on the top edge of the door at the two sides and push inwards to release the clip seal.</p>	
<p>Step 5</p>	<p>Pull the door trim to the front to remove it.</p>	
<p>Step 6</p>	<p>Hold the door glass panels on their top edge one by one and pull them up out of the guide.</p>	
<p>Step 7</p>	<p>Clean the glass panel with water and soap. Dry the glass panel carefully. Do not clean the glass panels in the dishwasher.</p>	
<p>Step 8</p>	<p>After cleaning, do the above steps in the opposite sequence.</p>	
<p>Step 9</p>	<p>Install the smaller panel first, then the larger and the door. Make sure that the glasses are inserted in the correct position otherwise the surface of the door may overheat.</p>	

11.12 How to replace: Lamp

⚠ WARNING!

Risk of electric shock.
The lamp can be hot.

Before you replace the lamp:

Step 1	Step 2	Step 3
<p>Turn off the oven. Wait until the oven is cold.</p>	<p>Disconnect the oven from the mains.</p>	<p>Put a cloth on the bottom of the cavity.</p>

Top lamp

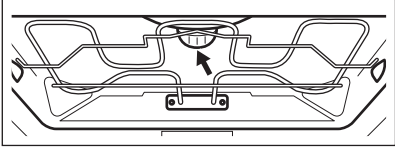
Step 1	Turn the glass cover to remove it.	 A technical line drawing of the top lamp assembly. It shows a rectangular metal frame with a central circular component. An arrow points to a small ring or cap on top of the central component, indicating the part to be turned for removal.
Step 2	Remove the metal ring and clean the glass cover.	
Step 3	Replace the lamp with a suitable 300 °C heat-resistant lamp.	
Step 4	Attach the metal ring to the glass cover and install it.	

12. TROUBLESHOOTING

WARNING!

Refer to Safety chapters.

12.1 What to do if...



The oven does not turn on or does not heat up



Possible cause



Remedy

The oven is not connected to an electrical supply or it is connected incorrectly.

Check if the oven is correctly connected to the electrical supply.

The clock is not set.

Set the clock, for details refer to "Clock Functions" chapter, How to set: Clock functions.

The door is not closed correctly.

Fully close the door.

The fuse is blown.

Make sure the fuse is the cause of the problem. If the problem recurs, contact a qualified electrician.

The oven Child Lock is on.

Refer to "Menu" chapter, Submenu for: Options.



Components



Description



Remedy

The lamp is burnt out.



Replace the lamp, for details refer to "Care and Cleaning" chapter, How to replace: Lamp.

Power cut always stops cleaning. Repeat cleaning if it's interrupted by power failure.

12.2 How to manage: Error codes

When the software error occurs, the display shows error message.

In this section, you will find the list of the problems that you can handle on your own.

 Code and description	 Remedy
F111 - Food sensor is not correctly inserted into the socket.	Fully plug Food sensor into the socket.
F240, F439 - the touch fields on the display do not work properly.	Clean the surface of the display. Make sure there is no dirt on the touch fields.
F908 - the oven system cannot connect with the control panel.	Turn the oven off and on.

12.3 Service data

If you cannot find a solution to the problem yourself, contact your dealer or an Authorised Service Centre.

The necessary data for the service centre is on the rating plate. The rating plate is on the front frame of the oven cavity. Do not remove the rating plate from the oven cavity.

We recommend that you write the data here:	
Model (MOD.)
Product number (PNC)
Serial number (S.N.)

13. ENERGY EFFICIENCY

13.1 Product Information and Product Information Sheet*

Supplier's name	Electrolux
Model identification	KVBAS21WX 944066889
Energy Efficiency Index	MISSING IN PS!
Energy efficiency class	MISSING IN PS!
Energy consumption with a standard load, conventional mode	MISSING IN PS! kWh/cycle
Energy consumption with a standard load, fan-forced mode	MISSING IN PS! kWh/cycle
Number of cavities	1
Heat source	Electricity
Volume	MISSING IN PS! l
Type of oven	Built-In Oven
Mass	35.8 kg

* For European Union according to EU Regulations 65/2014 and 66/2014.
For Republic of Belarus according to STB 2478-2017, Appendix G; STB 2477-2017, Annexes A and B.
For Ukraine according to 568/32020.

Energy efficiency class is not applicable for Russia.

EN 60350-1 - Household electric cooking appliances - Part 1: Ranges, ovens, steam ovens and grills - Methods for measuring performance.

13.2 Energy saving



The oven has features which help you save energy during everyday cooking.

Make sure that the oven door is closed when the oven operates. Do not open the oven door too often during cooking. Keep the door gasket clean and make sure it is well fixed in its position.

Use metal cookware to improve energy saving.

When possible, do not preheat the oven before cooking.

Keep breaks between baking as short as possible when you prepare a few dishes at one time.

Cooking with fan

When possible, use the cooking functions with fan to save energy.

Residual heat

If a programme with the Duration or End Time selection is activated and the cooking time is longer than 30 min, the heating elements automatically turn off earlier in some oven functions. The fan and lamp continue to operate. When you turn off the oven, the display shows the residual heat. You can use that heat to keep the food warm.

When the cooking duration is longer than 30 min, reduce the oven temperature to minimum 3 - 10 min before the end of cooking. The residual heat inside the oven will continue to cook.

Use the residual heat to warm up other dishes.

Keep food warm

Choose the lowest possible temperature setting to use residual heat and keep a meal warm.

The residual heat indicator or temperature appears on the display.

Cooking with the lamp off

Turn off the lamp during cooking. Turn it on only when you need it.

Moist Fan Baking

Function designed to save energy during cooking.

When you use this function the lamp automatically turns off after 30 sec. You may turn on the lamp again but this action will reduce the expected energy savings.

Standby mode

After 2 min the display goes to standby mode.

14. MENU STRUCTURE

14.1 Menu

Press  to open Menu.

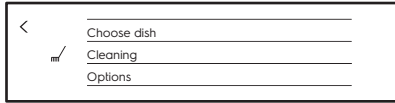

Menu item		Application
Favourites		Lists the favourite settings.
Assisted Cooking		Lists automatic programmes.
Cleaning		Lists cleaning programmes.
Options		To set the oven configuration.
Settings	Setup	To set the oven configuration.
	Service	Shows the software version and configuration.

14.2 Submenu for: Cleaning

Submenu	Application
Steam Cleaning	Light cleaning.
Steam Cleaning Plus	Thorough cleaning.
Descaling	Cleaning of the steam generation circuit from residual lime-stone.
Rinsing	Cleaning of the steam generation circuit. Use rinsing after frequent steam cooking.
Tank emptying	Procedure for removing the residual water from the water drawer after use of the steam functions.
Drying	Procedure for drying the cavity from the condensation remaining after a use of the steam functions.
Cleaning Reminder	Reminds you when to clean the oven.

14.3 Submenu for: Options

Submenu	Application
Light	Turns the lamp on and off.
Lamp Icon visible	Lamp icon appears on the screen.
Child Lock	Prevents accidental activation of the oven. When the option is on, the text "Child Lock" appears on the display when you turn on the oven. To enable the oven use, choose the code letters in the alphabetical order.
Fast Heat Up	Shortens heat up time. It is available only for some of the oven functions.

14.4 Submenu for: Setup

Submenu	Description
Language	Sets the oven language.
Time of day	Sets the current time and date.
Time indication	Turns the clock on and off.
Digital clock style	Changes the format of the displayed time indication.
Cleaning Reminder	Turns the reminder on and off.
Key tones	Turns the tone of the touch fields on and off. It is not possible to mute the tones for: ①, STOP .
Alarm/Error tones	Turns the alarm tones on and off.
Buzzer volume	Sets the volume of key tones and signals.
Display brightness	Sets the display brightness.
Water hardness	Sets the water hardness.

MENU STRUCTURE

14.5 Submenu for: Service







Submenu	Description
Demo mode	Activation / deactivation code: 2468
Licence	Information about licenses.
Software version	Information about software version.
Reset all settings	Restores factory settings.
Reset all popups	Restores all pop-ups to the original settings.

15. IT'S EASY!



Before the first use you have to set:

Language	Display brightness	Buzzer volume	Water hardness	Time of day	Wireless connection
----------	--------------------	---------------	----------------	-------------	---------------------





Familiarize yourself with the basic icons on the control panel and the display:

 ON / OFF	 Menu / Back	 Wi-Fi	 Information	 Timer	START / STOP	 More
---	--	--	--	--	--------------	--

Start using the oven

Quick start	Turn on the oven and start cooking with the default temperature and time of the function.	Step 1	Step 2	Step 3
		Press and hold: 	 ... - set the oven function.	Press: START .
Quick Off	Turn off the oven at any time, any screen or message.	 - press and hold until the oven turns off.		

Start cooking

Step 1	Step 2	Step 3	Step 4	Step 5	Step 6
 - press to turn on the oven.	 ... - select the function.	 - press to go to the temperature settings.	 - move the finger on the slider to set the temperature.	OK - press to confirm.	START - press to start cooking.



Steam cooking: Steamify

Set the temperature. Type of the steam heating function depends on the set temperature.





Steam for Steaming	Steam for Stewing	Steam for Gentle Crisping	Steam for Baking and Roasting
50 - 100 °C	105 - 130 °C	135 - 150 °C	155 - 230 °C

Get to know how to cook quickly



Use the automatic programmes to prepare a dish quickly with the default settings:

Assisted Cooking	Step 1	Step 2	Step 3	Step 4
	Press:  .	Press:  .	Press:  Assisted Cooking.	Choose the dish.

Use quick functions to set the cooking time or change the cooking function

Quick timer settings	Step 1	Step 2
Use the most used timer settings by choosing from the shortcuts.	Press:  .	Press the preferred timer value.
10% Finish assist Use 10% Finish assist to add extra time or change cooking function when 10% of the cooking time is left.	+1 min +5 min +10 min - press the preferred time icon to extend the cooking time.	
	Change function: Press preferred function:    ...	

Clean the oven with Steam cleaning

Step 1	Step 2	Step 3
Press:  .	Press:  .	Choose the mode:
Steam Cleaning		For light cleaning.
Steam Cleaning Plus		For thorough cleaning.
Descaling		For cleaning the steam generation circuit from residual limestone.
Rinsing		For rinsing and cleaning the steam generation circuit after frequent use of the steam functions.

16. TAKE A SHORTCUT!

Here you can see all the useful shortcuts. You can also find them in the dedicated chapters in the user manual.

How to set: Heating functions



How to set: Steamify - Cooking with a steam heating function



How to set: Assisted cooking



How to set: Cooking time



How to delay: Start and end of cooking





How to cancel: Set Timer



How to use: Food Sensor



17. ENVIRONMENTAL CONCERNS

Recycle materials with the symbol . Put the packaging in relevant containers to recycle it. Help protect the environment and human health by recycling waste of electrical and electronic appliances. Do not dispose of appliances marked with the symbol  with the household waste. Return the product to your local recycling facility or contact your municipal office.

www.electrolux.com/shop



867362933-A-102021

